

**CHASSIS SECTION**

This service manual has been prepared to provide SUBARU service personnel with the necessary information and data for the correct maintenance and repair of SUBARU vehicles.

This manual includes the procedures for maintenance, disassembling, reassembling, inspection and adjustment of components and diagnostics for guidance of experienced mechanics.

Please peruse and utilize this manual fully to ensure complete repair work for satisfying our customers by keeping their vehicle in optimum condition. When replacement of parts during repair work is needed, be sure to use SUBARU genuine parts.

All information, illustration and specifications contained in this manual are based on the latest product information available at the time of publication approval.

<b>FRONT SUSPENSION</b>	<b>FS</b>
<b>REAR SUSPENSION</b>	<b>RS</b>
<b>WHEEL AND TIRE SYSTEM</b>	<b>WT</b>
<b>DIFFERENTIALS</b>	<b>DI</b>
<b>TRANSFER CASE</b>	<b>TC</b>
<b>DRIVE SHAFT SYSTEM</b>	<b>DS</b>
<b>ABS</b>	<b>ABS</b>
<b>ABS (DIAGNOSTICS)</b>	<b>ABS(diag)</b>
<b>BRAKE</b>	<b>BR</b>
<b>PARKING BRAKE</b>	<b>PB</b>
<b>POWER ASSISTED SYSTEM (POWER STEERING)</b>	<b>PS</b>

# ABS (DIAGNOSTICS)

# *ABS(diag)*

---

	<b>Page</b>
1. Basic Diagnostic Procedure .....	2
2. Check List for Interview .....	4
3. General Description .....	8
4. Electrical Components Location.....	10
5. Control Module I/O Signal .....	12
6. Subaru Select Monitor.....	16
7. Read Diagnostic Trouble Code (DTC) .....	19
8. Inspection Mode .....	20
9. Clear Memory Mode.....	21
10. ABS Warning Light/Brake Warning Light Illumination Pattern .....	22
11. List of Diagnostic Trouble Code (DTC) .....	23
12. Diagnostics Procedure without Diagnostic Trouble Code (DTC) .....	26
13. Diagnostics Procedure with Diagnostic Trouble Code (DTC) .....	37
14. General Diagnostics Table.....	127

# Basic Diagnostic Procedure

ABS (DIAGNOSTICS)

## 1. Basic Diagnostic Procedure

### A: PROCEDURE

**CAUTION:**

Remove foreign matter (dust, water, etc.) from the ABSCM&H/U connector during removal and installation.

**NOTE:**

- To check the harness for broken wires or short circuits, shake it while holding it or the connector.
- Check list for interview. <Ref. to ABS(diag)-4, Check List for Interview.>

Step	Check	Yes	No
<b>1</b> <b>CHECK PRE-INSPECTION.</b> 1)Ask the customer when and how trouble occurred using interview checklist. <Ref. to ABS(diag)-4, Check List for Interview.> 2)Before performing diagnosis, inspect the unit which might influence the ABS problem. <Ref. to ABS(diag)-8, INSPECTION, General Description.>	Is the unit that might influence the ABS problem normal?	Go to step 2.	Repair or replace each unit.
<b>2</b> <b>CHECK INDICATION OF DTC DISPLAY.</b> 1)Turn the ignition switch to OFF. 2)Connect the SUBARU SELECT MONITOR to data link connector. 3)Turn the ignition switch to ON and SUBARU SELECT MONITOR to ON.  <b>NOTE:</b> If the communication function of Subaru Select Monitor cannot be executed normally, check communication circuit. <Ref. to ABS(diag)-37, COMMUNICATION FOR INITIALIZING IMPOSSIBLE, Diagnostics Procedure with Diagnostic Trouble Code (DTC).> 4)Read the DTC. <Ref. to ABS(diag)-17, READ CURRENT DATA, OPERATION, Subaru Select Monitor.> 5)Record all DTCs and freeze frame data.	Is the DTC displayed?	Go to step 4.	Go to step 3.
<b>3</b> <b>PERFORM THE GENERAL DIAGNOSTICS.</b> 1)Inspect using "General Diagnostics Table". <Ref. to ABS(diag)-127, General Diagnostics Table.> 2)Perform the clear memory mode. <Ref. to ABS(diag)-17, CLEAR MEMORY MODE, OPERATION, Subaru Select Monitor.> 3)Perform the inspection mode. <Ref. to ABS(diag)-20, Inspection Mode.> 4)Calling up the DTC. <Ref. to ABS(diag)-16, READ DIAGNOSTIC TROUBLE CODE (DTC), OPERATION, Subaru Select Monitor.> Check DTC is not displayed.	Is the ABS warning light turned off after ignition switch OFF?	Complete the diagnosis.	Inspect using "diagnostics procedure for No DTC". <Ref. to ABS(diag)-40, NO DTC.>

# Basic Diagnostic Procedure

ABS (DIAGNOSTICS)

Step	Check	Yes	No
<b>4</b> <b>PERFORM THE DIAGNOSIS.</b> 1)For the DTC list, refer to "List of DTC". <Ref. to ABS(diag)-23, WITH SUBARU SELECT MONITOR, LIST, List of Diagnostic Trouble Code (DTC).> 2)Repair trouble cause. 3)Perform the clear memory mode. <Ref. to ABS(diag)-17, CLEAR MEMORY MODE, OPERATION, Subaru Select Monitor.> 4)Perform the inspection mode. <Ref. to ABS(diag)-20, Inspection Mode.> 5)Calling up the DTC. <Ref. to ABS(diag)-16, READ DIAGNOSTIC TROUBLE CODE (DTC), OPERATION, Subaru Select Monitor.>	Are the DTCs indicated on display?	Inspect using "diagnostics procedure with Subaru Select Monitor". <Ref. to ABS(diag)-37, Diagnostics Procedure with Diagnostic Trouble Code (DTC).>	Complete the diagnosis.

## Check List for Interview

ABS (DIAGNOSTICS)

### 2. Check List for Interview

#### A: CHECK

Check the following items about the vehicle's state.

#### 1. STATE OF ABS WARNING LIGHT

ABS warning light comes on.	<input type="checkbox"/> Always <input type="checkbox"/> Sometimes <input type="checkbox"/> Only once <input type="checkbox"/> Does not come on • When / how long does it come on?:		
Ignition key position	<input type="checkbox"/> LOCK <input type="checkbox"/> ACC <input type="checkbox"/> ON (before starting engine) <input type="checkbox"/> START <input type="checkbox"/> On after starting (Engine is running) <input type="checkbox"/> On after starting (Engine is stop)		
Timing	<input type="checkbox"/> Immediately after ignition is ON. <input type="checkbox"/> Immediately after ignition starts.		
	<input type="checkbox"/> When advancing		km/h to km/h MPH to MPH
	<input type="checkbox"/> While traveling at a constant speed	km/h	MPH
	<input type="checkbox"/> When decelerating		km/h to km/h MPH to MPH
	<input type="checkbox"/> When turning to right	Steering angle :	deg
		Steering time :	sec
	<input type="checkbox"/> When turning to left	Steering angle :	deg
		Steering time :	sec
	<input type="checkbox"/> When moving other electrical parts • Parts name : • Operating condition :		

# Check List for Interview

ABS (DIAGNOSTICS)

## 2. STATE OF BRAKE WARNING LIGHT

Brake warning light comes on.	<input type="checkbox"/> Always <input type="checkbox"/> Sometimes <input type="checkbox"/> Only once <input type="checkbox"/> Does not come on <input type="checkbox"/> When parking brake lever is pulled <input type="checkbox"/> When parking brake lever is released <input type="checkbox"/> When / how long does it come on?:		
Ignition key position	<input type="checkbox"/> LOCK <input type="checkbox"/> ACC <input type="checkbox"/> ON (before starting engine) <input type="checkbox"/> START <input type="checkbox"/> On after starting (Engine is running) <input type="checkbox"/> On after starting (Engine is stop)		
Timing	<input type="checkbox"/> Immediately after ignition is ON. <input type="checkbox"/> Immediately after ignition starts.		
	<input type="checkbox"/> When advancing	km/h to	km/h
		MPH to	MPH
	<input type="checkbox"/> While traveling at a constant speed	km/h	MPH
	<input type="checkbox"/> When decelerating	km/h to	km/h
		MPH to	MPH
	<input type="checkbox"/> When turning to right	Steering angle :	deg
		Steering time :	sec
	<input type="checkbox"/> When turning to left	Steering angle :	deg
		Steering time :	sec
	<input type="checkbox"/> When operating other electrical parts <input type="checkbox"/> Parts name : <input type="checkbox"/> Operating condition :		

## Check List for Interview

ABS (DIAGNOSTICS)

### 3. SYMPTOMS

ABS operating condition	<input type="checkbox"/> Does not operate.		
	<input type="checkbox"/> Operates only when abruptly applying brakes.	Vehicle speed :	km/h
			MPH
	• How to step on brake pedal :		
	a) Operating time :		sec
	b) Operating noise : <input type="checkbox"/> Produce / <input type="checkbox"/> Does not produce		
	• What kind of noise?	<input type="checkbox"/> Knock <input type="checkbox"/> Gong gong <input type="checkbox"/> Bong <input type="checkbox"/> Buzz <input type="checkbox"/> Gong gong buzz <input type="checkbox"/> Others :	
c) Reaction force of brake pedal			
	<input type="checkbox"/> Stick <input type="checkbox"/> Press down once with a clunk <input type="checkbox"/> Press and released <input type="checkbox"/> Others :		
Behavior of vehicle	a) Directional stability cannot be obtained or steering refuses to work when applying brakes : <input type="checkbox"/> Yes / <input type="checkbox"/> No		
	• When :	<input type="checkbox"/> Vehicle turns to right <input type="checkbox"/> Vehicle turns to left <input type="checkbox"/> Spins <input type="checkbox"/> Others :	
	b) Directional stability cannot be obtained or steering refuses to work when accelerating : <input type="checkbox"/> Yes / <input type="checkbox"/> No		
	• When :	<input type="checkbox"/> Vehicle turns to right <input type="checkbox"/> Vehicle turns to left <input type="checkbox"/> Spins <input type="checkbox"/> Others :	
	c) Brakes out of order : <input type="checkbox"/> Yes / <input type="checkbox"/> No		
	• What :	<input type="checkbox"/> Braking distance is long <input type="checkbox"/> Brakes lock or drag <input type="checkbox"/> Pedal stroke is long <input type="checkbox"/> Pedal sticks <input type="checkbox"/> Others :	
	d) Poor acceleration : <input type="checkbox"/> Yes / <input type="checkbox"/> No		
	• What :	<input type="checkbox"/> Fails to accelerate <input type="checkbox"/> Engine stalls <input type="checkbox"/> Others :	
	e) Occurrence of vibration : <input type="checkbox"/> Yes / <input type="checkbox"/> No		
	• Where		
	• What kind :		
	f) Occurrence of abnormal noise : <input type="checkbox"/> Yes / <input type="checkbox"/> No		
	• Where		
• What kind :			
g) Occurrence of other phenomena : <input type="checkbox"/> Yes / <input type="checkbox"/> No			
• What kind :			

# Check List for Interview

ABS (DIAGNOSTICS)

## 4. CONDITIONS UNDER WHICH TROUBLE OCCURS

Environment	a) Weather	<input type="checkbox"/> Fine <input type="checkbox"/> Cloudy <input type="checkbox"/> Rainy <input type="checkbox"/> Snowy <input type="checkbox"/> Various/Others :		
	b) Ambient temperature	°C (°F)		
	c) Road	<input type="checkbox"/> Urban area <input type="checkbox"/> Suburbs <input type="checkbox"/> Highway <input type="checkbox"/> General road <input type="checkbox"/> Ascending slope <input type="checkbox"/> Descending slope <input type="checkbox"/> Paved road <input type="checkbox"/> Gravel road <input type="checkbox"/> Muddy road <input type="checkbox"/> Sandy place <input type="checkbox"/> Others :		
	d) Road surface	<input type="checkbox"/> Dry <input type="checkbox"/> Wet <input type="checkbox"/> New-fallen snow <input type="checkbox"/> Compressed snow <input type="checkbox"/> Frozen slope <input type="checkbox"/> Others :		
Condition	a) Brakes	Deceleration : <span style="float: right;">g</span>		
		<input type="checkbox"/> Continuous / <input type="checkbox"/> Intermittent		
	b) Accelerator	Acceleration : <span style="float: right;">g</span>		
		<input type="checkbox"/> Continuous / <input type="checkbox"/> Intermittent		
	c) Vehicle speed	km/h	MPH	
		<input type="checkbox"/> Advancing <input type="checkbox"/> Accelerating <input type="checkbox"/> Reducing speed <input type="checkbox"/> Low speed <input type="checkbox"/> Turning <input type="checkbox"/> Others :		
	d) Tire inflation pressure	Front RH tire :	kPa	
		Front LH tire :	kPa	
		Rear RH tire :	kPa	
		Rear LH tire :	kPa	
	e) Degree of wear	Front RH tire :		
		Front LH tire :		
		Rear RH tire :		
		Rear LH tire :		
f) Genuine parts are used. :	<input type="checkbox"/> Yes / <input type="checkbox"/> No			
g) Chain is passed around tires. :	<input type="checkbox"/> Yes / <input type="checkbox"/> No			
h) T tire is used. :	<input type="checkbox"/> Yes / <input type="checkbox"/> No			
i) Condition of suspension alignment :				
j) Loading state :				
k) Repair parts are used. :	<input type="checkbox"/> Yes / <input type="checkbox"/> No			
• What :				
l) Others :				



## 3. General Description

### A: CAUTION

#### 1. SUPPLEMENTAL RESTRAINT SYSTEM “AIRBAG”

Airbag system wiring harness is routed near the ABS wheel speed sensor, ABS control module and hydraulic control unit.

#### CAUTION:

- All airbag system wiring harness and connectors are colored yellow. Do not use electrical test equipment on these circuit.
- Be careful not to damage the airbag system wiring harness when servicing the ABS wheel speed sensor, ABS control module and hydraulic control unit.

### B: INSPECTION

Before performing diagnostics, check the following items which might affect ABS problems:

#### 1. BATTERY

Measure the battery voltage and specific gravity of electrolyte.

**Standard voltage: 12 V, or more**

**Specific gravity: Above 1.260**

#### 2. BRAKE FLUID

- 1) Check the brake fluid level.
- 2) Check the brake fluid leakage.

#### 3. HYDRAULIC UNIT

Check the hydraulic unit.

- With brake tester <Ref. to ABS-8, CHECKING THE HYDRAULIC UNIT ABS OPERATION WITH BRAKE TESTER, INSPECTION, ABS Control Module and Hydraulic Control Unit (ABSCM&H/U).>
- Without brake tester <Ref. to ABS-7, CHECKING THE HYDRAULIC UNIT ABS OPERATION BY PRESSURE GAUGE, INSPECTION, ABS Control Module and Hydraulic Control Unit (ABSCM&H/U).>

#### 4. BRAKE DRAG

Check for brake drag.

#### 5. BRAKE PAD AND ROTOR

Check the brake pad and rotor.

- Front <Ref. to BR-27, INSPECTION, Front Brake Pad.> and <Ref. to BR-29, INSPECTION, Front Disc Rotor.>



- Rear <Ref. to BR-38, INSPECTION, Rear Brake Pad.> and <Ref. to BR-40, INSPECTION, Rear Disc Rotor.> or <Ref. to BR-48, INSPECTION, Rear Drum Brake Shoe.> and <Ref. to BR-49, INSPECTION, Rear Drum Brake Drum.>

#### 6. TIRE

Check the tire specifications, tire wear and air pressure. <Ref. to WT-2, SPECIFICATIONS, General Description.>

## C: PREPARATION TOOL

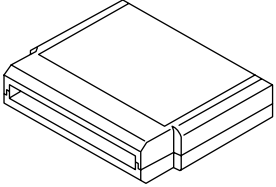
### 1. SPECIAL TOOLS

ILLUSTRATION	TOOL NUMBER	DESCRIPTION	REMARKS
  ST24082AA230	24082AA230	CARTRIDGE	Troubleshooting for electrical systems.
  ST22771AA030	22771AA030	SUBARU SELECT MONITOR KIT	Troubleshooting for electrical systems.

### 2. GENERAL PURPOSE TOOLS

TOOL NAME	REMARKS
Circuit tester	Used for measuring resistance, voltage and amperage.
Oscilloscope	Used for measuring sensor.

# Electrical Components Location

ABS (DIAGNOSTICS)

## 4. Electrical Components Location

### A: LOCATION

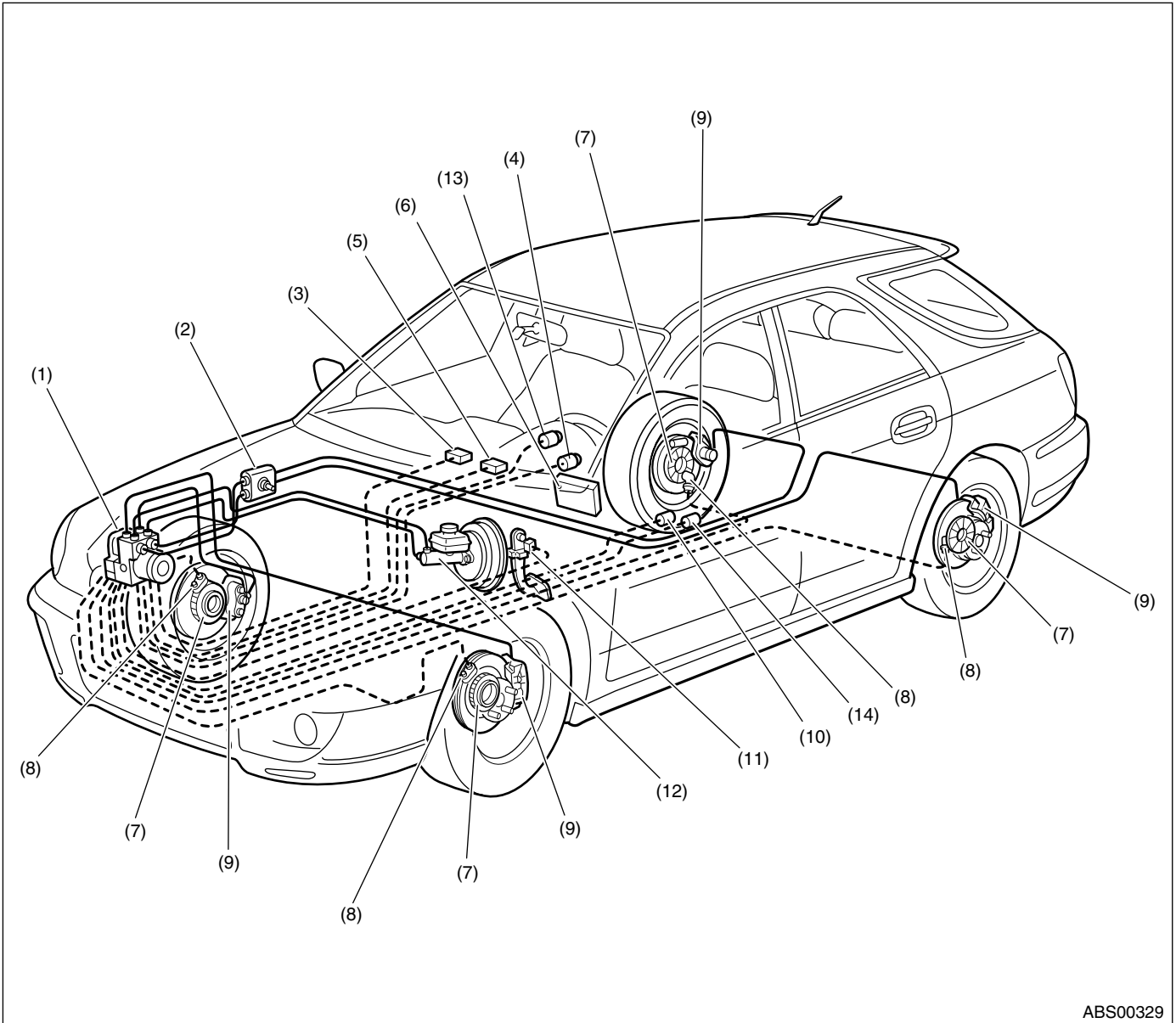

ABS00329

- |   |  |                                   |
|---|--|-----------------------------------|
| (1) ABS control module and hydraulic control unit (ABSCM&H/U) | (6) Transmission control module (TCM) (AT model) | (12) Master cylinder              |
| (2) Connector   | (7) Tone wheel                                   | (13) Brake & EBD warning light    |
| (3) Diagnosis connector                                       | (8) ABS wheel speed sensor                       | (14) Lateral G sensor (STi model) |
| (4) ABS warning light   | (9) Wheel cylinder                               |                                   |
| (5) Data link connector (for Subaru Select Monitor)           | (10) G sensor                                    |                                   |
|   | (11) Stop light switch                           |                                   |

# Electrical Components Location

ABS (DIAGNOSTICS)

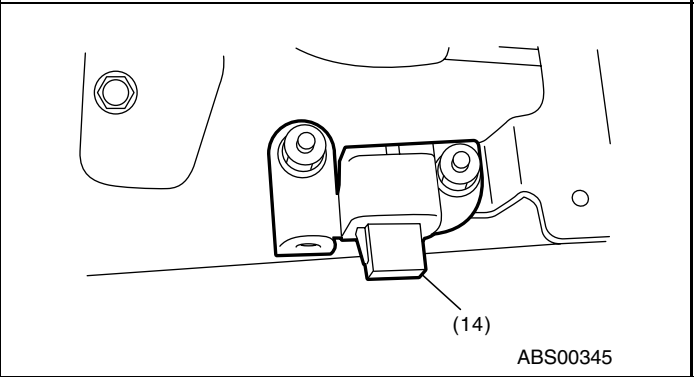
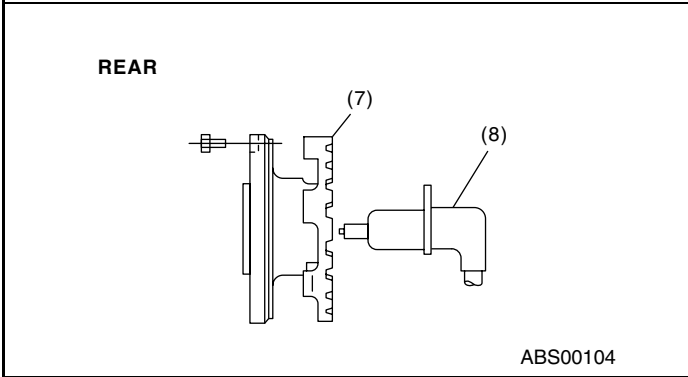
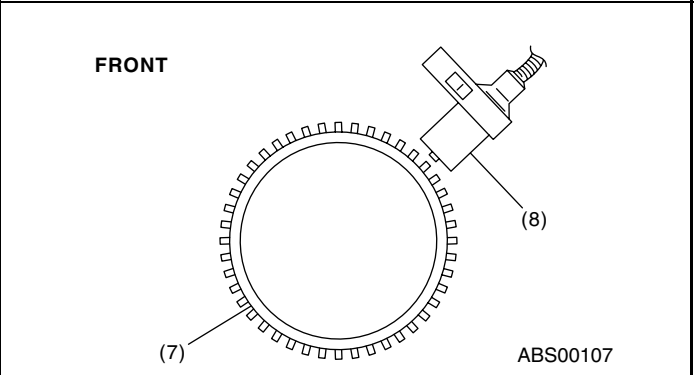
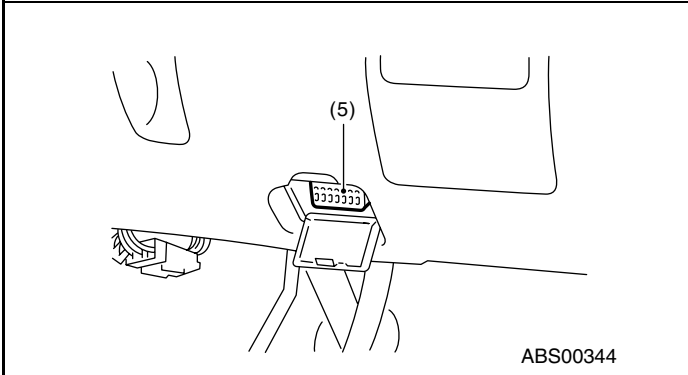
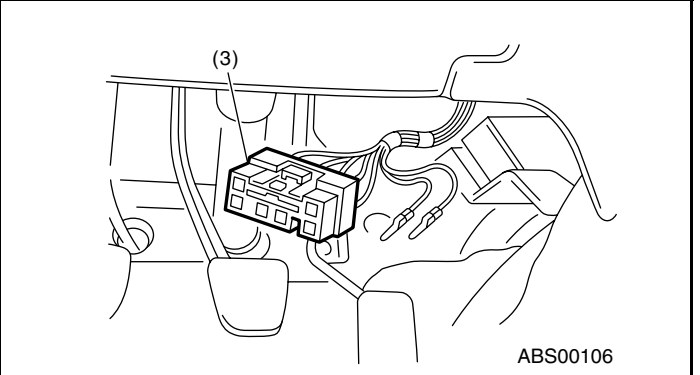
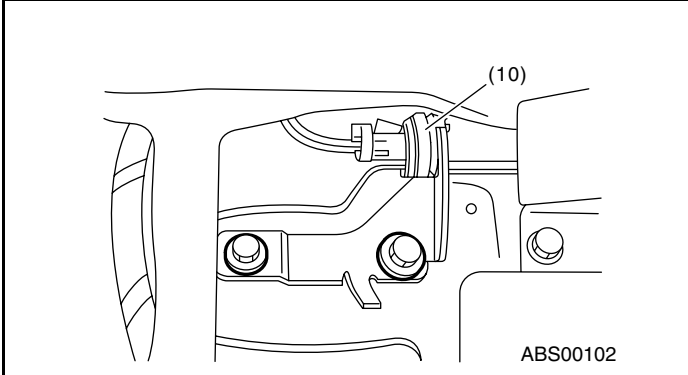
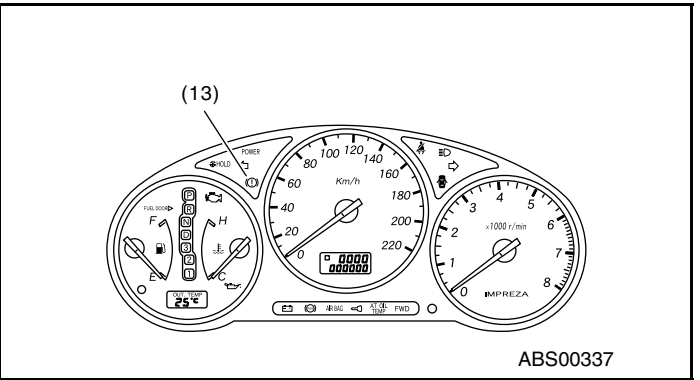
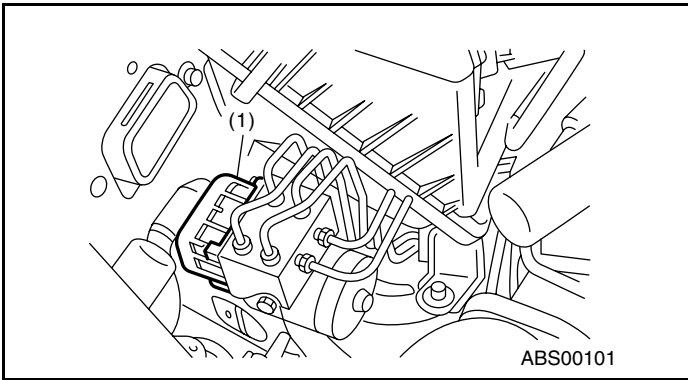

## 5. Control Module I/O Signal

### A: ELECTRICAL SPECIFICATION

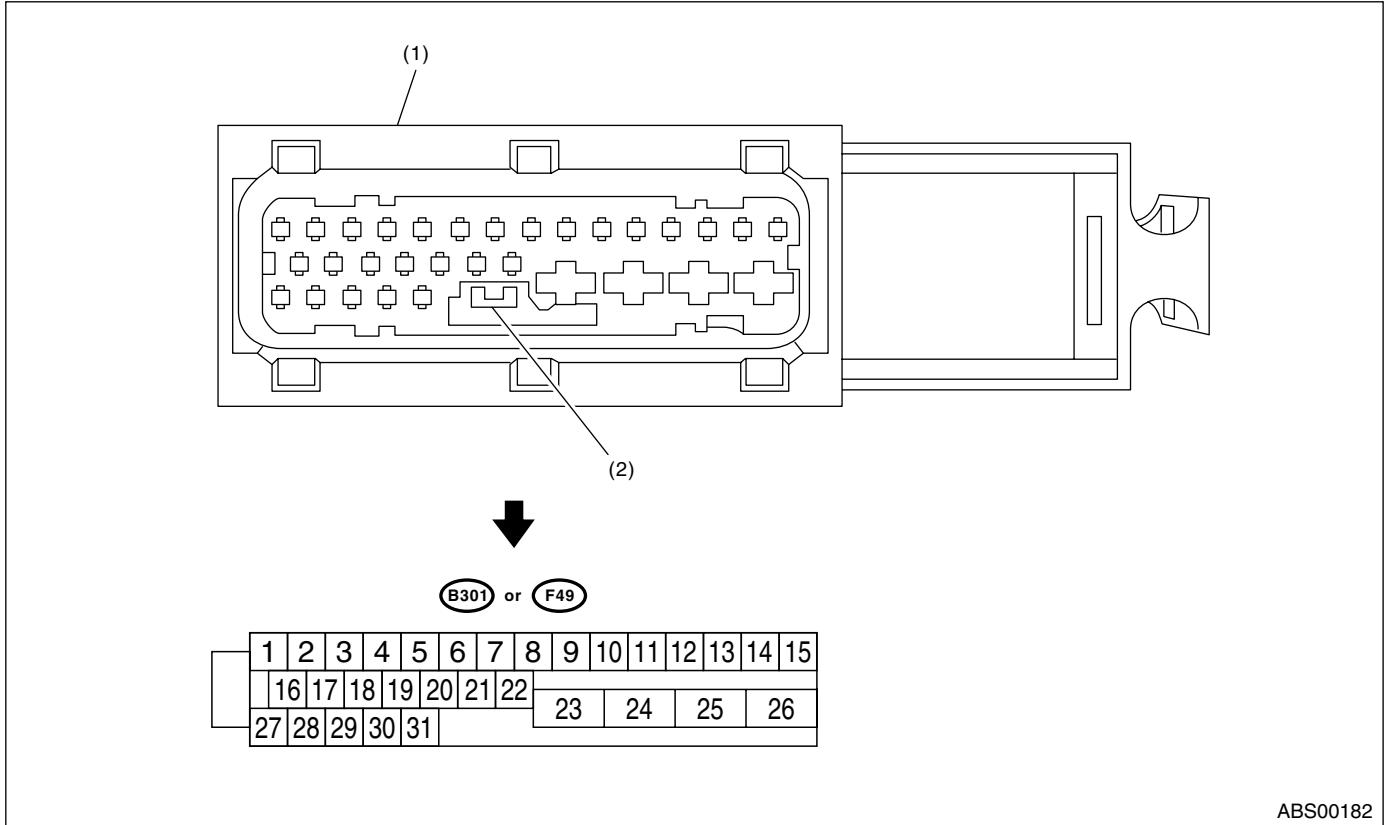

- (1) ABS control module and hydraulic control unit (ABSCM&H/U) connector      (2) Connector switch

**NOTE:**

- The terminal numbers in ABS control module and hydraulic control unit connector are as shown in the figure.
- When the connector is removed from ABSCM&H/U, the connector switch closes the circuit between terminal No. 22 and No. 23. The ABS warning light illuminates.

# Control Module I/O Signal

ABS (DIAGNOSTICS)

Contents		Terminal No. (+) — (-)	Input/Output signal
			Measured value and measuring conditions
ABS wheel speed sensor*2 (Wheel speed sensor)	Front left wheel	9 — 10	0.12 — 1 V (When it is 20 Hz.)
	Front right wheel	11 — 12	
	Rear left wheel	7 — 8	
	Rear right wheel	14 — 15	
Valve relay power supply*1		24 — 23	10 — 15 V
Motor relay power supply*1		25 — 23	10 — 15 V
G sensor*2	Power supply	30 — 28	4.75 — 5.25 V
	Ground	28	—
	Output	6 — 28	2.1 — 2.5 V when vehicle is in horizontal position.
Lateral G sensor (STi model)	Power supply	30 — 28	4.75 — 5.25 V
	Ground	28	—
	Output	29 — 28	2.3 — 2.7 V when vehicle is in horizontal position.
Stop light switch*1		2 — 23	Less than 1.5 V when the stop light is OFF and, 10 — 15 V when the stop light is ON.
ABS warning light*2		22 — 23	Less than 1.5 V within 1.5 seconds immediately after ignition switch has been turned to ON, and 10 — 15 V after 1.5 seconds has elapsed.
Brake warning light*2 (EBD warning light)		21 — 23	Less than 1.5 V within 1.5 seconds immediately after ignition switch has been turned to ON, and 10 — 15 V after 1.5 seconds has elapsed.
AT ABS signal (AT models only)		31 — 23	Less than 1.5 V when the ABS control still operates and more than 5.5 V when ABS does not operate.
ABS operation signal monitor		3 — 23	Less than 1.5 V when the ABS control still operates and more than 5.5 V when ABS does not operate.
Subaru Select Monitor*2	Data is received.	20 — 23	Less than 1.5 V when no data is received.
	Data is sent.	5 — 23	4.75 — 5.25 V when no data is sent.
ABS diagnosis connector	Terminal No. 3	29 — 23	10 — 15 V when ignition switch is ON.
	Terminal No. 6	4 — 23	10 — 15 V when ignition switch is ON.
Power supply*1		1 — 23	10 — 15 V when ignition switch is ON.
Grounding line		23	—
Grounding line		26	—

\*1: Measure the I/O signal voltage after removing the connector from the ABSCM&H/U terminal.

\*2: Measure the I/O signal voltage at connector (F2).

# Control Module I/O Signal

ABS (DIAGNOSTICS)

## B: WIRING DIAGRAM

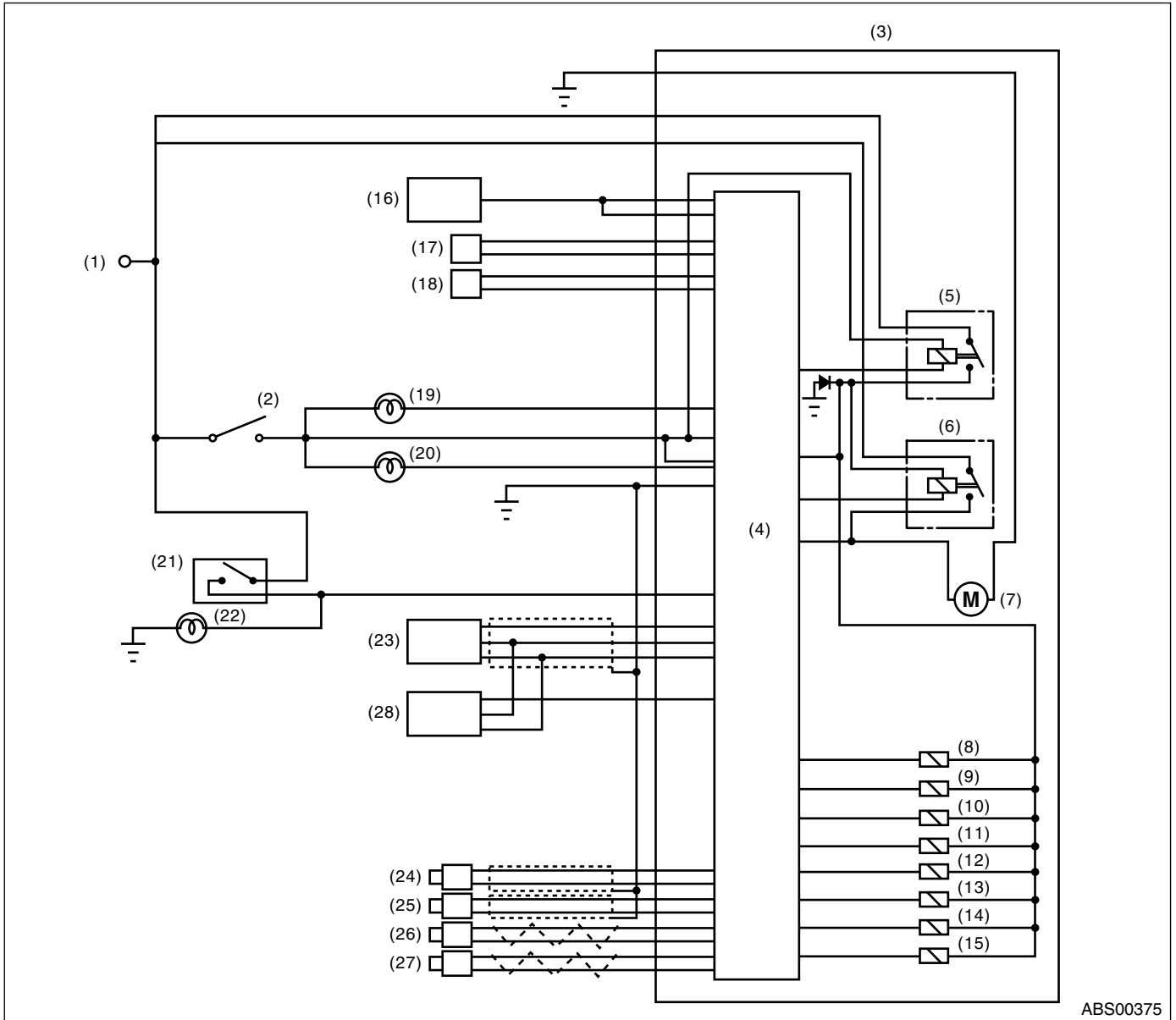

ABS00375

- |   |   |                                      |
|---|---|--------------------------------------|
| (1) Battery   | (12) Rear inlet solenoid valve LH                 | (23) G sensor                        |
| (2) IGN   | (13) Rear outlet solenoid valve LH                | (24) Front ABS wheel speed sensor LH |
| (3) ABS control module and hydraulic control unit (ABSCM&H/U) | (14) Rear inlet solenoid valve RH                 | (25) Front ABS wheel speed sensor RH |
| (4) ABS control module area                                   | (15) Rear outlet solenoid valve RH                | (26) Rear ABS wheel speed sensor LH  |
| (5) Valve relay   | (16) Transmission control module (TCM) (AT model) | (27) Rear ABS wheel speed sensor RH  |
| (6) Motor relay   | (17) Diagnosis connector                          | (28) Lateral G sensor (STi model)    |
| (7) Motor   | (18) Data link connector                          |                                      |
| (8) Front inlet solenoid valve LH                             | (19) Brake warning light                          |                                      |
| (9) Front outlet solenoid valve LH                            | (20) ABS warning light                            |                                      |
| (10) Front inlet solenoid valve RH                            | (21) Stop light switch                            |                                      |
| (11) Front outlet solenoid valve RH                           | (22) Stop light                                   |                                      |

## C: WAVEFORM

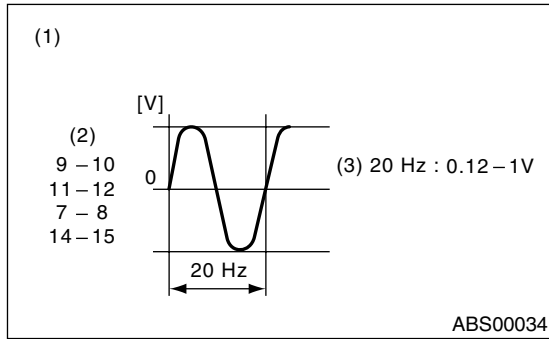

- (1) ABS wheel speed sensor
- (2) Terminal No.
- (3) Standard output voltage



## 6. Subaru Select Monitor

### A: OPERATION

#### 1. READ DIAGNOSTIC TROUBLE CODE (DTC)

1) Prepare the Subaru Select Monitor kit.



2) Connect the diagnosis cable to Subaru Select Monitor.

3) Insert the cartridge into Subaru Select Monitor. <Ref. to ABS(diag)-9, SPECIAL TOOLS, PREPARATION TOOL, General Description.>

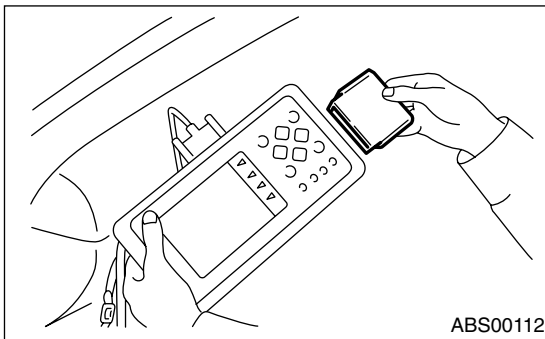

4) Connect the Subaru Select Monitor to data link connector.

(1) Data link connector located in the lower portion of instrument panel (on the driver's side).

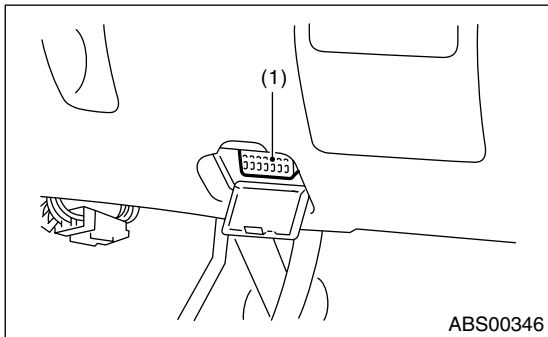

(1) Data link connector

(2) Connect the diagnosis cable to data link connector.

#### CAUTION:

Do not connect the scan tools except for Subaru Select Monitor and OBD-II general scan tool.

5) Turn the ignition switch to ON (engine OFF) and Subaru Select Monitor switch to ON.

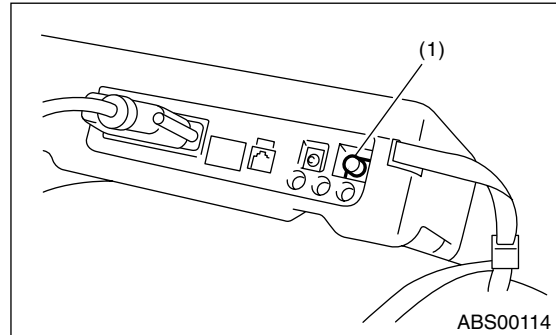

(1) Power switch

6) On the «Main Menu» display screen, select the {Each System Check} and press [YES] key.

7) On the «System Selection Menu» display screen, select the {Brake Control System} and press [YES] key.

8) Press the [YES] key after the information of ABS type is displayed.

9) On the «ABS Diagnosis» display screen, select the {DTC Display} and press [YES] key.

10) On the «DTC Display» display screen, select the {Current DTC} or {History DTC} and press [YES] key.

#### NOTE:

- For detailed operation procedure, refer to the SUBARU SELECT MONITOR OPERATION MANUAL.

- For detailed concerning the DTC, refer to the LIST OF DTC. <Ref. to ABS(diag)-23, List of Diagnostic Trouble Code (DTC).>

- A maximum of 3 DTCs are displayed in order of occurrence.

- If a particular DTC is not properly stored in memory (due to a drop in ABSCM&H/U power supply, etc.) when a problem occurs, the DTC, followed by a question mark "?", appears on the Subaru Select Monitor display. This shows it may be an unreliable reading.

Display screen	Contents to be monitored
Current	The most recent DTC appears on Subaru Select Monitor display.
Old	The second most recent DTC appears on Subaru Select Monitor display.
Older	The third most recent DTC appears on Subaru Select Monitor display.
Before 3	DTC issued after elapse of a specified period of time.

## 2. READ CURRENT DATA

- 1) On the «Main Menu» display screen, select the {Each System Check} and press «YES» key.
- 2) On the «System Selection Menu» display screen, select the {Brake Control System} and press «YES» key.
- 3) Press the «YES» key after the information of ABS type is displayed.
- 4) On the «Brake Control Diagnosis» display screen, select the {Current Data Display & Save} and press «YES» key.
- 5) On the «Data Display Menu» display screen, select the {Data Display} and press «YES» key.
- 6) Using the scroll key, move the display screen up or down until desired data is shown.
  - A list of the support data is shown in the following table.

Display screen	Contents to be monitored	Unit of measure
FR Wheel Speed	Wheel speed detected by Front ABS wheel speed sensor RH is displayed	km/h or MPH
FL Wheel Speed	Wheel speed detected by Front ABS wheel speed sensor LH is displayed	km/h or MPH
RR Wheel Speed	Wheel speed detected by Rear ABS wheel speed sensor RH is displayed	km/h or MPH
RL Wheel Speed	Wheel speed detected by Rear ABS wheel speed sensor LH is displayed	km/h or MPH
Stop Light Switch	Stop light switch signal	ON or OFF
Stop Light Switch	Stop light switch monitor voltage is displayed.	V
G Sensor Output Signal	Voltage equivalent to vehicle acceleration detected by analog G sensor is displayed.	V
Lateral G Sensor Output Signal	Lateral G detected by Lateral G sensor is displayed in voltage. (STi model)	V
Valve Relay Signal	Valve Relay Signal	ON or OFF
Motor Relay Signal	Motor Relay Signal	ON or OFF
ABS Signal to TCM	ABS operation signal from ABS control module to TCM	ON or OFF
ABS Warning Lamp	ON operation of ABS warning light is displayed.	ON or OFF
EBD Warning Light	ON operation of EBD warning light is displayed.	ON or OFF
Motor Relay Monitor	Operating condition of motor relay is displayed.	ON or OFF
Valve Relay Monitor	Operating condition of the valve relay is displayed.	ON or OFF
CCM Signal	ABS operation signal from ABS control module to TCM	ON or OFF

**NOTE:**

For detailed operation procedure, refer to the SUBARU SELECT MONITOR OPERATION MANUAL.

## 3. CLEAR MEMORY MODE

- 1) On the «Main Menu» display screen, select the {2. Each System Check} and press «YES» key.
- 2) On the «System Select Menu» display screen, select the {Brake System} and press «YES» key.
- 3) Press the «YES» key after the information of engine type is displayed.
- 4) On the «Brake Control Diagnosis» display screen, select the {Clear Memory} and press «YES» key.

Display screen	Contents to be monitored
Clear memory?	Function of clearing DTC.

- 5) When the “Done” and “turn ignition switch to OFF” are shown on display screen, turn the Subaru Select Monitor and ignition switch to OFF.

**NOTE:**

For detailed operation procedure, refer to the SUBARU SELECT MONITOR OPERATION MANUAL.

## 4. ABS SEQUENCE CONTROL

Display screen	Contents to be monitored	Index No.
ABS sequence control	Perform ABS sequence control by operating valve and pump motor sequentially.	<Ref. to ABS-10, ABS Sequence Control.>

# Subaru Select Monitor

## ABS (DIAGNOSTICS)

### 5. FREEZE FRAME DATA

**NOTE:**

- Data stored at the time of trouble occurrence is shown on display.
- Each time trouble occurs, the latest information is stored in the freeze frame data in memory.
- Freeze frame data will be memorized maximum to three.
- If freeze frame data is not properly stored in memory (due to a drop in ABSCM power supply, etc.), a DTC, preceded by a question mark “?”, appears on the Subaru Select Monitor display. This shows it may be an unreliable reading.

Display screen	Contents to be monitored
FR wheel speed	Wheel speed detected by Front ABS wheel speed sensor RH is displayed in km/h or mile/h.
FL wheel speed	Wheel speed detected by Front ABS wheel speed sensor LH is displayed in km/h or mile/h.
RR wheel speed	Wheel speed detected by Rear ABS wheel speed sensor RH is displayed in km/h or mile/h.
RL wheel speed	Wheel speed detected by Rear ABS wheel speed sensor LH is displayed in km/h or mile/h.
ABSCM power voltage	Power (in volts) supplied to ABSCM& H/U appears on the Subaru Select Monitor display.
G sensor output voltage	Voltage equivalent to vehicle acceleration detected by analog G sensor is displayed.
Lateral G sensor output voltage	Voltage equivalent to Lateral G detected by analog Lateral G sensor is displayed.
Motor relay monitor	Motor relay operation monitor signal
Stop light switch	Stop light switch signal
ABS signal to TCM	ABS operation signal from ABS control module to TCM
ABS-AT control	ABS operation signal from ABS control module to TCM
ABS operation signal	ABS operation signal
Condition of malfunction	Displays if the malfunction has occurred to ABS only, or to ABS and EBD.

### 6. ANALOG DATA ARE DISPLAYED

Display screen	Contents to be monitored
FR wheel speed	Wheel speed detected by Front ABS wheel speed sensor RH is displayed in km/h or mile/h.
FL wheel speed	Wheel speed detected by Front ABS wheel speed sensor LH is displayed in km/h or mile/h.

Display screen	Contents to be monitored
RR wheel speed	Wheel speed detected by Rear ABS wheel speed sensor RH is displayed in km/h or mile/h.
RL wheel speed	Wheel speed detected by Rear ABS wheel speed sensor LH is displayed in km/h or mile/h.
Stop light switch	Stop light switch monitor voltage is displayed.
G sensor output voltage	Refers to vehicle acceleration detecting by analog G sensor. It appears on the Subaru Select Monitor display in volts.
Lateral G sensor output voltage	Voltage equivalent to Lateral G detected by analog Lateral G sensor is displayed.

### 7. ON/OFF DATA ARE DISPLAYED

Display screen	Contents to be monitored
Stop light switch	Stop light switch signal
Valve relay signal	Valve relay signal
Motor relay signal	Motor relay signal
ABS signal to TCM	ABS operation signal from ABS control module to TCM
ABS warning light	ABS warning light
Valve relay monitor	Valve relay operation monitor signal
Motor relay monitor	Motor relay operation monitor signal
CCM signal	ABS operation signal from ABS control module to TCM

### **7. Read Diagnostic Trouble Code (DTC)**

#### **A: OPERATION**

Refer to SUBARU SELECT MONITOR for information about how to obtain and understand DTCs.  
<Ref. to ABS(diag)-16, Subaru Select Monitor.>

### **8. Inspection Mode**

#### **A: OPERATION**

Reproduce the condition under which the problem has occurred as much as possible.

Drive the vehicle at a speed more than 40 km/h (25 MPH) for at least 1 minute.

## 9. Clear Memory Mode

### A: OPERATION

Refer to SUBARU SELECT MONITOR for information about how to clear DTC. <Ref. to ABS(diag)-16, Subaru Select Monitor.>

# ABS Warning Light/Brake Warning Light Illumination Pattern

ABS (DIAGNOSTICS)

## 10.ABS Warning Light/Brake Warning Light Illumination Pattern

### A: INSPECTION

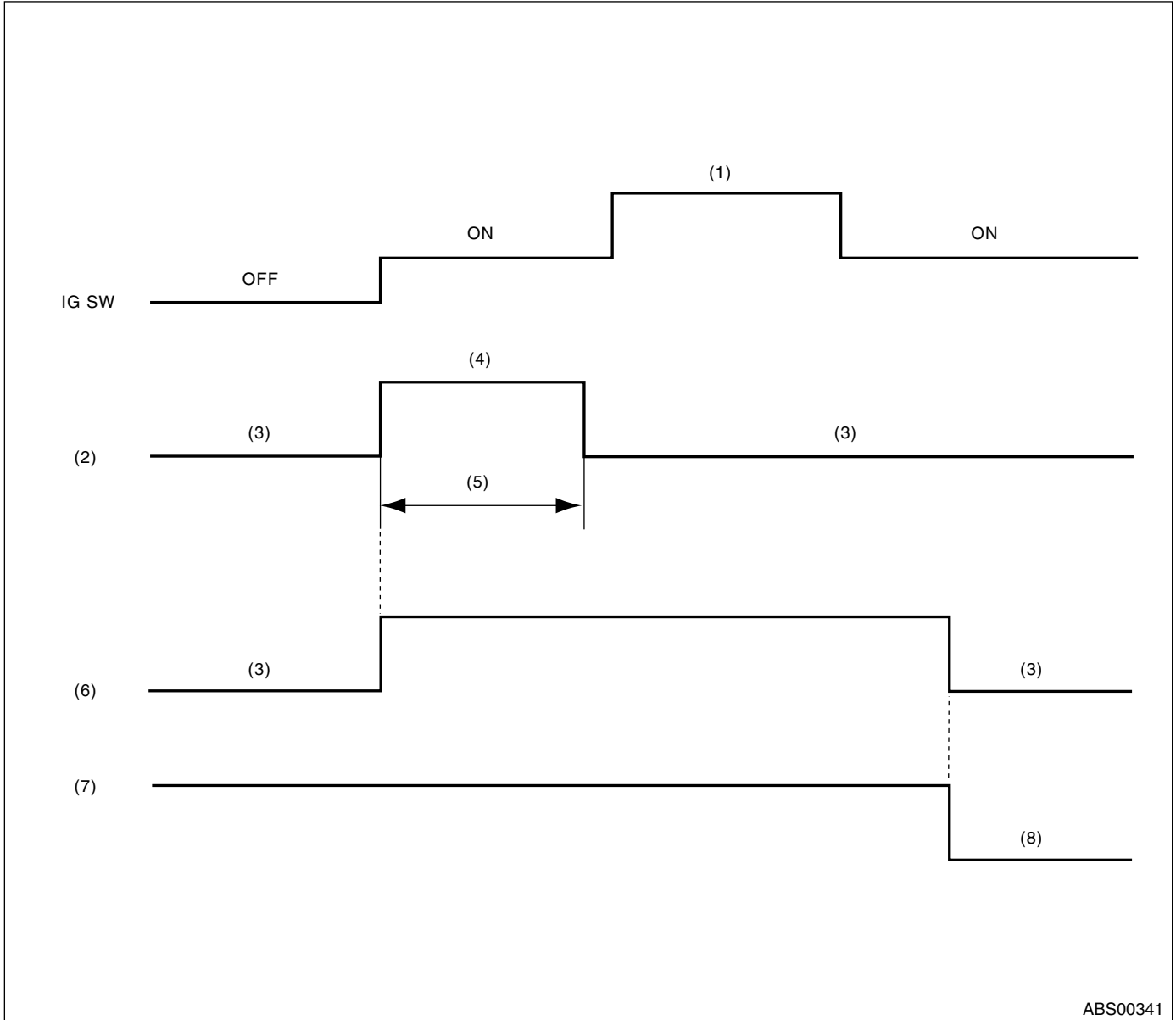

ABS00341

- |                       |                         |                   |
|-----------------------|-------------------------|-------------------|
| (1) START             | (4) Illuminates         | (7) Parking brake |
| (2) ABS warning light | (5) 1.5 sec.            | (8) Release       |
| (3) Goes out          | (6) Brake warning light |                   |

1) When the ABS warning light does not illuminate in accordance with this illumination pattern, there must be an electrical malfunction.

2) When the ABS warning light remains constantly OFF, repair the ABS warning light circuit or diagnosis circuit. <Ref. to ABS(diag)-26, Diagnostics Procedure without Diagnostic Trouble Code (DTC).>

#### NOTE:

Even though the ABS warning light does not go out 1.5 seconds after it illuminates, the ABS system operates normally when the warning light goes out while driving at approx. 12 km/h (7 MPH). However, the Anti-lock brakes do not work while ABS warning light is illuminated.

## 11. List of Diagnostic Trouble Code (DTC)

### A: LIST

#### 1. WITHOUT SUBARU SELECT MONITOR

DTC	Contents of diagnosis	Index No.
—	ABS warning light does not illuminate.	<Ref. to ABS(diag)-26, ABS WARNING LIGHT DOES NOT COME ON, Diagnostics Procedure without Diagnostic Trouble Code (DTC).>
—	ABS warning light remains on.	<Ref. to ABS(diag)-30, ABS WARNING LIGHT DOES NOT GO OFF, Diagnostics Procedure without Diagnostic Trouble Code (DTC).>
—	Brake warning light remains on.	<Ref. to ABS(diag)-34, BRAKE WARNING LIGHT DO NOT GO OFF, Diagnostics Procedure without Diagnostic Trouble Code (DTC).>

#### 2. WITH SUBARU SELECT MONITOR

DTC	Sub code No.	Display screen	Contents of diagnosis	Index No.
—	—	Communication for initializing impossible	Subaru Select Monitor communication failure	<Ref. to ABS(diag)-37, COMMUNICATION FOR INITIALIZING IMPOSSIBLE, Diagnostics Procedure with Diagnostic Trouble Code (DTC).>
—	—	No DTC	Although no DTC appears on the Subaru Select Monitor display, the ABS warning light remains on.	<Ref. to ABS(diag)-40, NO DTC, Diagnostics Procedure with Diagnostic Trouble Code (DTC).>
21	4A02	Open or short circuit in Front ABS wheel speed sensor RH circuit	Open or short circuit in Front ABS wheel speed sensor RH circuit	<Ref. to ABS(diag)-43, DTC 21 OPEN OR SHORT CIRCUIT IN FRONT RIGHT ABS WHEEL SPEED SENSOR CIRCUIT, Diagnostics Procedure with Diagnostic Trouble Code (DTC).>
22	48C5, 4945 48E5, 4845 4905, 4885	Front ABS wheel speed sensor RH abnormal signal	Front ABS wheel speed sensor RH abnormal signal	<Ref. to ABS(diag)-51, DTC 22 FRONT RIGHT ABNORMAL ABS WHEEL SPEED SENSOR SIGNAL, Diagnostics Procedure with Diagnostic Trouble Code (DTC).>
23	4202	Open or short circuit in Front ABS wheel speed sensor LH circuit	Open or short circuit in Front ABS wheel speed sensor LH circuit	<Ref. to ABS(diag)-43, DTC 23 OPEN OR SHORT CIRCUIT IN FRONT LEFT ABS WHEEL SPEED SENSOR CIRCUIT, Diagnostics Procedure with Diagnostic Trouble Code (DTC).>
24	40C5, 4145 40E5, 4045 4105, 4085	Front ABS wheel speed sensor LH abnormal signal	Front ABS wheel speed sensor LH abnormal signal	<Ref. to ABS(diag)-51, DTC 24 FRONT LEFT ABNORMAL ABS WHEEL SPEED SENSOR SIGNAL, Diagnostics Procedure with Diagnostic Trouble Code (DTC).>
25	4602	Open or short circuit in Rear ABS wheel speed sensor RH circuit	Open or short circuit in Rear ABS wheel speed sensor RH circuit	<Ref. to ABS(diag)-43, DTC 25 OPEN OR SHORT CIRCUIT IN REAR RIGHT ABS WHEEL SPEED SENSOR CIRCUIT, Diagnostics Procedure with Diagnostic Trouble Code (DTC).>
26	44C5, 4545 44E5, 4445 4505, 4485	Rear ABS wheel speed sensor RH abnormal signal	Rear ABS wheel speed sensor RH abnormal signal	<Ref. to ABS(diag)-51, DTC 26 REAR RIGHT ABNORMAL ABS WHEEL SPEED SENSOR SIGNAL, Diagnostics Procedure with Diagnostic Trouble Code (DTC).>
27	4E02	Open or short circuit in Rear ABS wheel speed sensor LH circuit	Open or short circuit in Rear ABS wheel speed sensor LH circuit	<Ref. to ABS(diag)-44, DTC 27 OPEN OR SHORT CIRCUIT IN REAR LEFT ABS WHEEL SPEED SENSOR CIRCUIT, Diagnostics Procedure with Diagnostic Trouble Code (DTC).>
28	4CC5, 4D45 4CE5, 4C45 4D05, 4C85	Rear ABS wheel speed sensor LH abnormal signal	Rear ABS wheel speed sensor LH abnormal signal	<Ref. to ABS(diag)-52, DTC 28 REAR LEFT ABNORMAL ABS WHEEL SPEED SENSOR SIGNAL, Diagnostics Procedure with Diagnostic Trouble Code (DTC).>



## List of Diagnostic Trouble Code (DTC)

### ABS (DIAGNOSTICS)

DTC	Sub code No.	Display screen	Contents of diagnosis	Index No.
29	5080 50C0	Abnormal ABS wheel speed sensor signal on any one of four sensor	Abnormal ABS wheel speed sensor signal on any one of four	<Ref. to ABS(diag)-58, DTC 29 ABNORMAL ABS WHEEL SPEED SENSOR SIGNAL ON ANY ONE OF FOUR SENSOR, Diagnostics Procedure with Diagnostic Trouble Code (DTC).>
31	3200	Front inlet valve RH malfunction	Front inlet valve RH malfunction	<Ref. to ABS(diag)-62, DTC 31 FRONT RIGHT INLET VALVE MALFUNCTION, Diagnostics Procedure with Diagnostic Trouble Code (DTC).>
32	3600	Front outlet valve RH malfunction	Front outlet valve RH malfunction	<Ref. to ABS(diag)-65, DTC 32 FRONT RIGHT OUTLET VALVE MALFUNCTION, Diagnostics Procedure with Diagnostic Trouble Code (DTC).>
33	2200	Front inlet valve LH malfunction	Front inlet valve LH malfunction	<Ref. to ABS(diag)-62, DTC 33 FRONT LEFT INLET VALVE MALFUNCTION, Diagnostics Procedure with Diagnostic Trouble Code (DTC).>
34	2600	Front outlet valve LH malfunction	Front outlet valve LH malfunction	<Ref. to ABS(diag)-65, DTC 34 FRONT LEFT OUTLET VALVE MALFUNCTION, Diagnostics Procedure with Diagnostic Trouble Code (DTC).>
35	2A00	Rear inlet valve RH malfunction	Rear inlet valve RH malfunction	<Ref. to ABS(diag)-62, DTC 35 REAR RIGHT INLET VALVE MALFUNCTION, Diagnostics Procedure with Diagnostic Trouble Code (DTC).>
36	2E00	Rear outlet valve RH malfunction	Rear outlet valve RH malfunction	<Ref. to ABS(diag)-65, DTC 36 REAR RIGHT OUTLET VALVE MALFUNCTION, Diagnostics Procedure with Diagnostic Trouble Code (DTC).>
37	3A00	Rear inlet valve LH malfunction	Rear inlet valve LH malfunction	<Ref. to ABS(diag)-63, DTC 37 REAR LEFT INLET VALVE MALFUNCTION, Diagnostics Procedure with Diagnostic Trouble Code (DTC).>
38	3E00	Rear outlet valve LH malfunction	Rear outlet valve LH malfunction	<Ref. to ABS(diag)-66, DTC 38 REAR LEFT OUTLET VALVE MALFUNCTION, Diagnostics Procedure with Diagnostic Trouble Code (DTC).>
41	02A0, 0040, 0020, 02C0, 00E0, 0340, 0140, 0160, 0280, 0460, 0260, 0060, 0080, 0300	ABS control module malfunction	ABS control module and hydraulic control unit malfunction	<Ref. to ABS(diag)-69, DTC 41 ABS CONTROL MODULE MALFUNCTION, Diagnostics Procedure with Diagnostic Trouble Code (DTC).>
42	5A00	Power supply voltage too low	Power supply voltage too low	<Ref. to ABS(diag)-71, DTC 42 POWER SUPPLY VOLTAGE TOO LOW, Diagnostics Procedure with Diagnostic Trouble Code (DTC).>
	5A80	Power supply voltage too high	Power supply voltage too high	<Ref. to ABS(diag)-74, DTC 42 POWER SUPPLY VOLTAGE TOO HIGH, Diagnostics Procedure with Diagnostic Trouble Code (DTC).>
44	1600	ABS-AT control (Non Controlled)	ABS-AT control (Non Controlled)	<Ref. to ABS(diag)-77, DTC 44 ABS-AT CONTROL (NON CONTROLLED), Diagnostics Procedure with Diagnostic Trouble Code (DTC).>
	1500	ABS-AT control (Controlled)	ABS-AT control (Controlled)	<Ref. to ABS(diag)-79, DTC 44 ABS-AT CONTROL (CONTROLLED), Diagnostics Procedure with Diagnostic Trouble Code (DTC).>
51	0C80 0EA0	Valve relay malfunction	Valve relay malfunction	<Ref. to ABS(diag)-81, DTC 51 VALVE RELAY MALFUNCTION, Diagnostics Procedure with Diagnostic Trouble Code (DTC).>
	0C40	Valve relay ON failure	Valve relay ON failure	<Ref. to ABS(diag)-83, DTC 51 VALVE RELAY ON FAILURE, Diagnostics Procedure with Diagnostic Trouble Code (DTC).>

# List of Diagnostic Trouble Code (DTC)

ABS (DIAGNOSTICS)

DTC	Sub code No.	Display screen	Contents of diagnosis	Index No.
52	10A1	Open circuit in motor relay circuit	Open circuit in motor relay circuit	<Ref. to ABS(diag)-85, DTC 52 OPEN CIRCUIT IN MOTOR RELAY CIRCUIT, Diagnostics Procedure with Diagnostic Trouble Code (DTC).>
	10E1	Motor relay ON failure	Motor relay ON failure	<Ref. to ABS(diag)-87, DTC 52 MOTOR RELAY ON FAILURE, Diagnostics Procedure with Diagnostic Trouble Code (DTC).>
	10C1	Motor malfunction	Motor malfunction	<Ref. to ABS(diag)-89, DTC 52 MOTOR MALFUNCTION, Diagnostics Procedure with Diagnostic Trouble Code (DTC).>
54	5600	Stop light switch signal circuit malfunction	Stop light switch signal circuit malfunction	<Ref. to ABS(diag)-91, DTC 54 STOP LIGHT SWITCH SIGNAL CIRCUIT MALFUNCTION, Diagnostics Procedure with Diagnostic Trouble Code (DTC).>
56	7600	Open or short circuit in G sensor circuit	Open or short circuit in G sensor circuit	<Ref. to ABS(diag)-93, DTC 56 OPEN OR SHORT CIRCUIT IN G SENSOR CIRCUIT, Diagnostics Procedure with Diagnostic Trouble Code (DTC).>
	7580	Battery short in G sensor circuit	Battery short in G sensor circuit	<Ref. to ABS(diag)-97, DTC 56 BATTERY SHORT IN G SENSOR CIRCUIT, Diagnostics Procedure with Diagnostic Trouble Code (DTC).>
	7540	Abnormal G sensor high $\mu$ output	Abnormal G sensor high $\mu$ output	<Ref. to ABS(diag)-102, DTC 56 ABNORMAL G SENSOR HIGH m OUTPUT, Diagnostics Procedure with Diagnostic Trouble Code (DTC).>
	7500	Detection of G sensor stick	Detection of G sensor stick	<Ref. to ABS(diag)-106, DTC 56 DETECTION OF G SENSOR STICK, Diagnostics Procedure with Diagnostic Trouble Code (DTC).>
73	7A00	Open or short circuit in Lateral G sensor circuit	Open or short circuit in Lateral G sensor circuit	<Ref. to ABS(diag)-110, DTC 73 OPEN OR SHORT CIRCUIT IN LATERAL G SENSOR CIRCUIT, Diagnostics Procedure with Diagnostic Trouble Code (DTC).>
	7980	Battery short in Lateral G sensor circuit	Battery short in Lateral G sensor circuit	<Ref. to ABS(diag)-114, DTC 73 BATTERY SHORT IN LATERAL G SENSOR CIRCUIT, Diagnostics Procedure with Diagnostic Trouble Code (DTC).>
	7940	Abnormal Lateral G sensor high $\mu$ output	Abnormal Lateral G sensor high $\mu$ output	<Ref. to ABS(diag)-119, DTC 73 ABNORMAL LATERAL G SENSOR HIGH m OUTPUT, Diagnostics Procedure with Diagnostic Trouble Code (DTC).>
	7900	Detection of Lateral G sensor stick	Detection of Lateral G sensor stick	<Ref. to ABS(diag)-123, DTC 73 DETECTION OF LATERAL G SENSOR STICK, Diagnostics Procedure with Diagnostic Trouble Code (DTC).>

# Diagnostics Procedure without Diagnostic Trouble Code (DTC)

ABS (DIAGNOSTICS)

## 12. Diagnostics Procedure without Diagnostic Trouble Code (DTC)

### A: ABS WARNING LIGHT DOES NOT COME ON

#### DIAGNOSIS:

- ABS warning light circuit is open or shorted.

#### TROUBLE SYMPTOM:

- When the ignition switch is turned to ON (engine OFF), ABS warning light does not come on.

#### WIRING DIAGRAM:

LHD MODEL

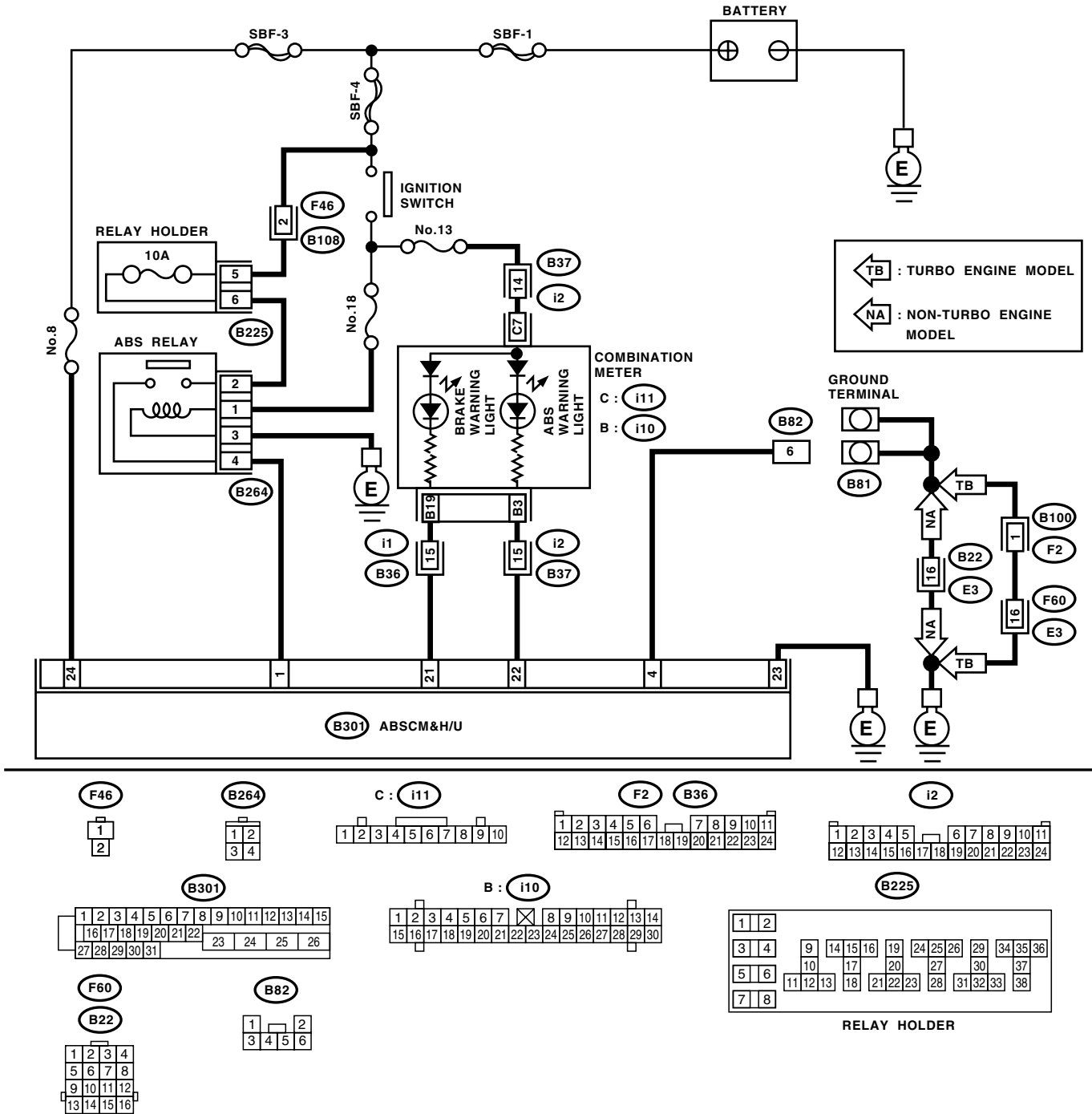

ABS00347

# Diagnostics Procedure without Diagnostic Trouble Code (DTC)

ABS (DIAGNOSTICS)

RHD MODEL

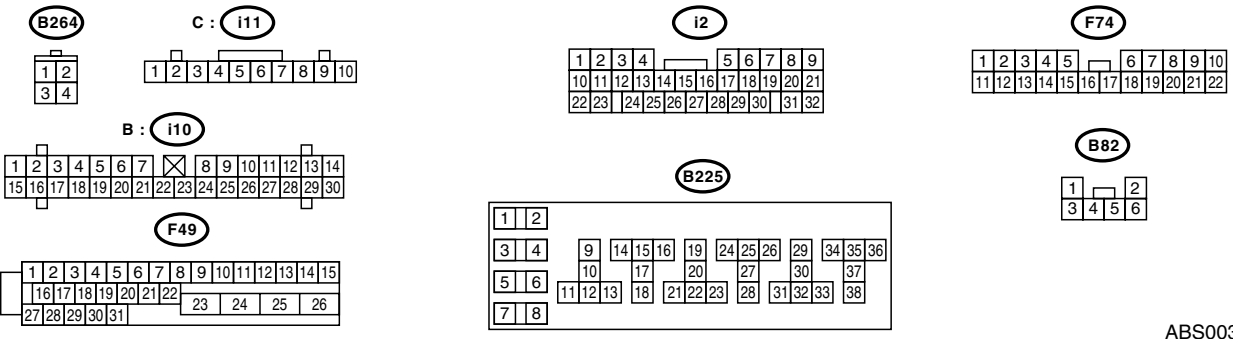
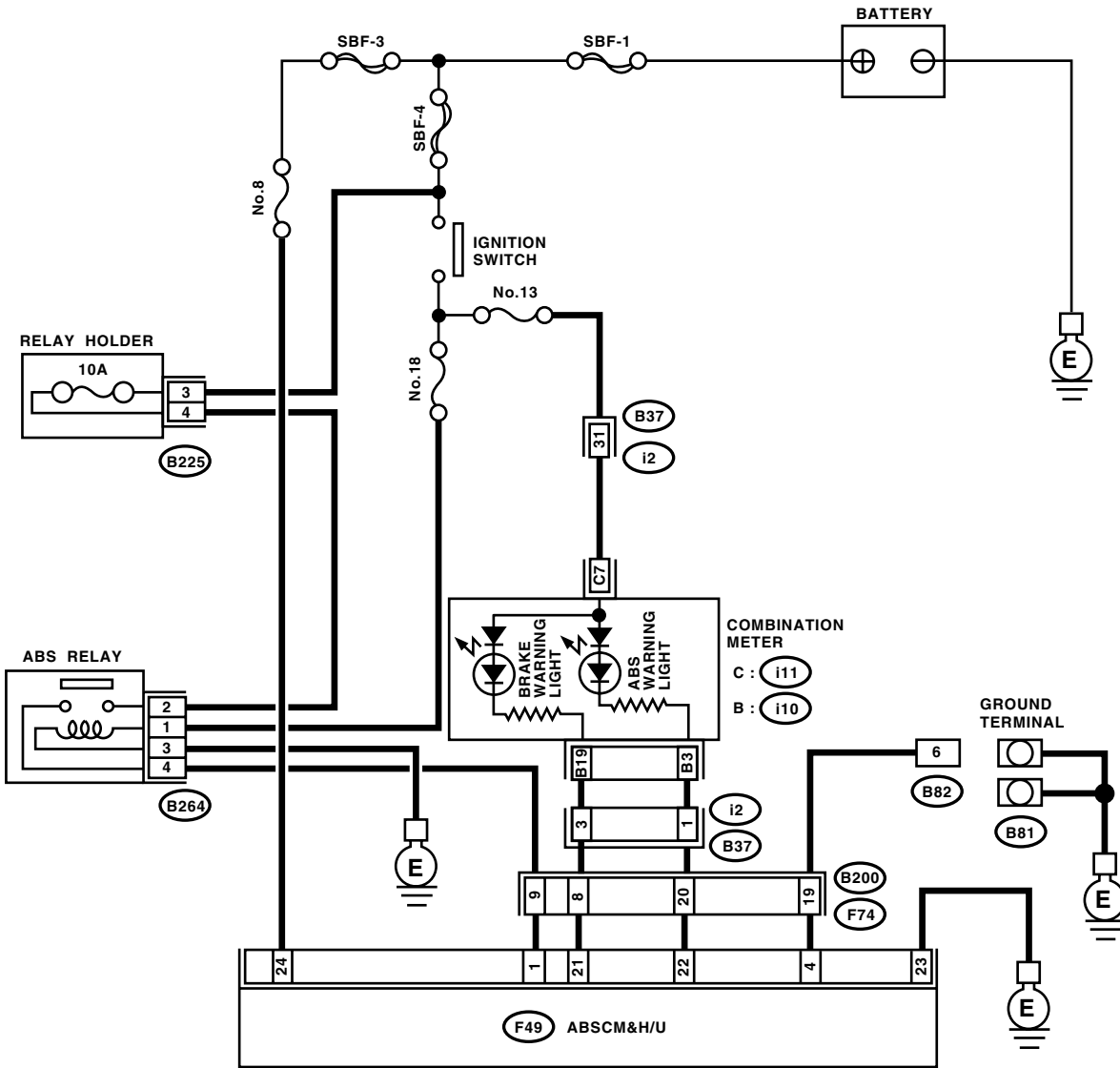

ABS00348

Step	Check	Yes	No
1	<p><b>CHECK IF OTHER WARNING LIGHTS TURN ON.</b> Turn the ignition switch to ON (engine OFF).</p>	Go to step 2.	Repair the combination meter. <Ref. to IDI-11, Combination Meter Assembly.>

## Diagnostics Procedure without Diagnostic Trouble Code (DTC)

### ABS (DIAGNOSTICS)

Step	Check	Yes	No
<b>2</b> <b>CHECK ABS AND BRAKE WARNING LIGHT BULB.</b> 1) Turn the ignition switch to OFF. 2) Remove the combination meter. 3) Remove the ABS warning light and brake warning light.	Is the ABS warning light bulb open?	Replace the ABS and brake warning light bulb. <Ref. to IDI-11, Combination Meter Assembly.>	Go to step 3.
<b>3</b> <b>CHECK BATTERY SHORT OF ABS HARNESS.</b> 1) Disconnect the connector (i2) from connector (B37). 2) Measure the voltage between connector (i2) and chassis ground. <b>Connector &amp; terminal</b> <b>LHD: (i2) No. 15 (+) — Chassis ground (-):</b> <b>RHD: (i2) No. 1 (+) — Chassis ground (-):</b>	Is the voltage less than 3 V?	Go to step 4.	Repair battery short in the warning light harness.
<b>4</b> <b>CHECK BATTERY SHORT OF ABS AND BRAKE WARNING LIGHT HARNESS.</b> 1) Turn the ignition switch to ON. 2) Measure the voltage between connector (i2) and chassis ground. <b>Connector &amp; terminal</b> <b>LHD: (i2) No. 15 (+) — Chassis ground (-):</b> <b>RHD: (i2) No. 1 (+) — Chassis ground (-):</b>	Is the voltage less than 3 V?	Go to step 5.	Repair battery short in the warning light harness.
<b>5</b> <b>CHECK WIRING HARNESS.</b> 1) Turn the ignition switch to OFF. 2) Install the combination meter. 3) Turn the ignition switch to ON. 4) Measure the voltage between connector (i2) and chassis ground. <b>Connector &amp; terminal</b> <b>LHD: (i2) No. 15 (+) — Chassis ground (-):</b> <b>RHD: (i2) No. 1 (+) — Chassis ground (-):</b>	Is the voltage 10 — 15 V?	Go to step 6.	Repair open circuit in the wiring harness.
<b>6</b> <b>CHECK BATTERY SHORT OF ABS AND BRAKE WARNING LIGHT HARNESS.</b> 1) Turn the ignition switch to OFF. 2) Measure the voltage between connector (B37) and chassis ground. <b>Connector &amp; terminal</b> <b>LHD: (B37) No. 15 (+) — Chassis ground (-):</b> <b>RHD: (B37) No. 1 (+) — Chassis ground (-):</b>	Is the voltage less than 3 V?	Go to step 7.	Repair battery short in the wiring harness.
<b>7</b> <b>CHECK BATTERY SHORT OF ABS AND BRAKE WARNING LIGHT HARNESS.</b> 1) Turn the ignition switch to ON. 2) Measure the voltage between connector (B37) and chassis ground. <b>Connector &amp; terminal</b> <b>LHD: (B37) No. 15 (+) — Chassis ground (-):</b> <b>RHD: (B37) No. 1 (+) — Chassis ground (-):</b>	Is the voltage less than 3 V?	Go to step 8.	Repair battery short in the wiring harness.

# Diagnostics Procedure without Diagnostic Trouble Code (DTC)

ABS (DIAGNOSTICS)

Step	Check	Yes	No
<b>8</b> <b>CHECK GROUND CIRCUIT OF ABSCM&amp;H/U.</b> 1) Turn the ignition switch to OFF. 2) Disconnect the connector from ABSCM&H/U. 3) Measure the resistance between ABSCM&H/U and chassis ground. <i>Connector &amp; terminal</i> <i>LHD: (B301) No. 23 — Chassis ground:</i> <i>RHD: (F49) No. 23 — Chassis ground:</i>	Is the resistance less than 0.5 $\Omega$ ?	Go to step <b>9</b> .	Repair open circuit in the ABSCM&H/U ground harness.
<b>9</b> <b>CHECK WIRING HARNESS.</b> Measure the resistance between connector (B37) and chassis ground. <i>Connector &amp; terminal</i> <i>LHD: (B37) No. 15 — Chassis ground:</i> <i>RHD: (B37) No. 1 — Chassis ground:</i>	Is the resistance less than 0.5 $\Omega$ ?	Go to step <b>10</b> .	Repair open circuit in the harness/connector.
<b>10</b> <b>CHECK POOR CONTACT IN CONNECTORS.</b> Turn the ignition switch to OFF.	Is there poor contact in connectors between combination meter and ABSCM&H/U?	Repair the connector.	Replace the ABSCM only. <Ref. to ABS-6, ABS Control Module and Hydraulic Control Unit (ABSCM&H/U).>

# Diagnostics Procedure without Diagnostic Trouble Code (DTC)

ABS (DIAGNOSTICS)

## B: ABS WARNING LIGHT DOES NOT GO OFF

### DIAGNOSIS:

- ABS warning light circuit is open or shorted.

### TROUBLE SYMPTOM:

- When starting the engine and while ABS warning light is kept ON.

### WIRING DIAGRAM:

LHD MODEL

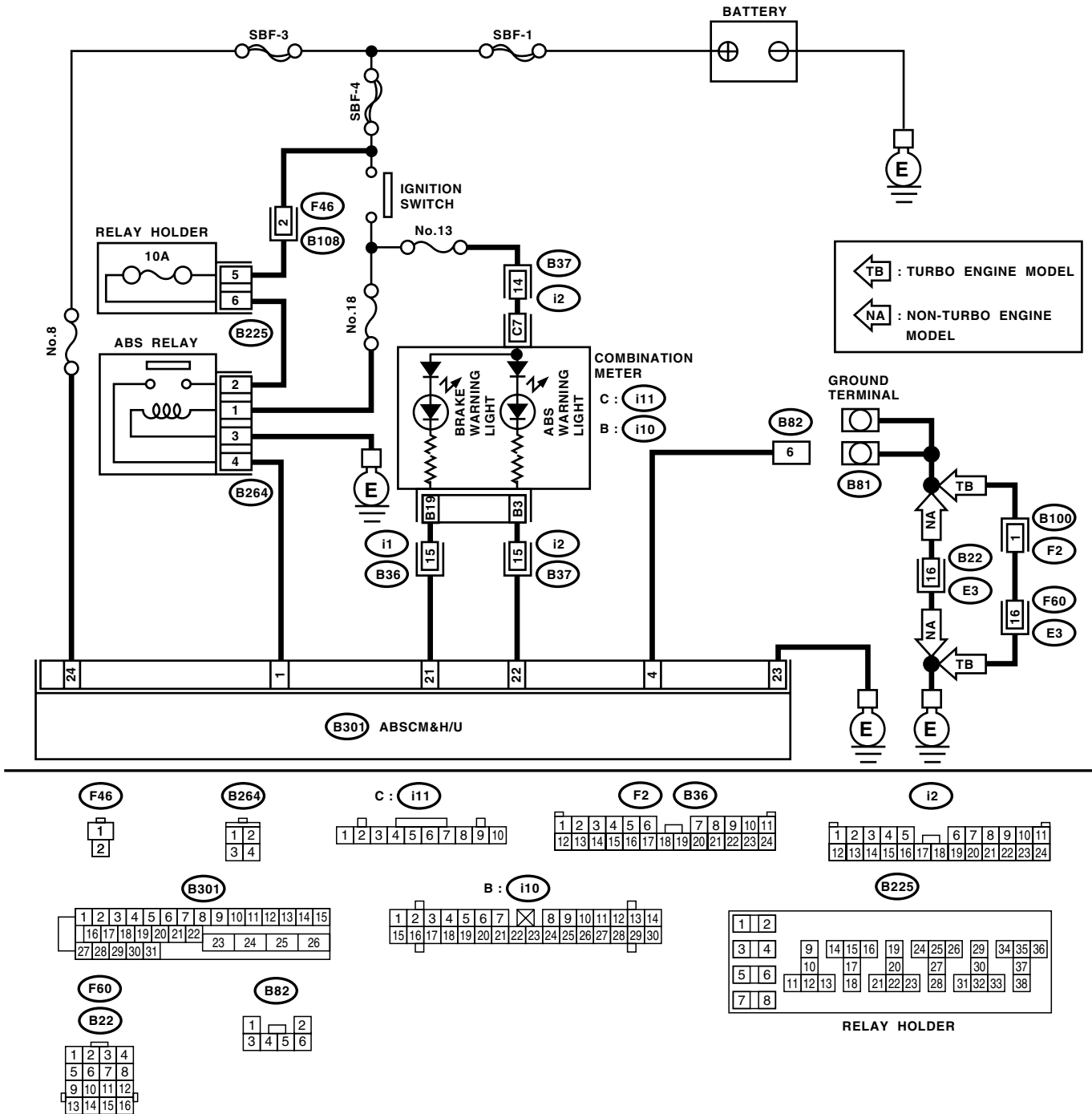

ABS00347

# Diagnostics Procedure without Diagnostic Trouble Code (DTC)

ABS (DIAGNOSTICS)

## RHD MODEL

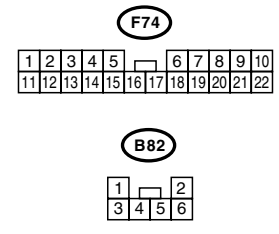
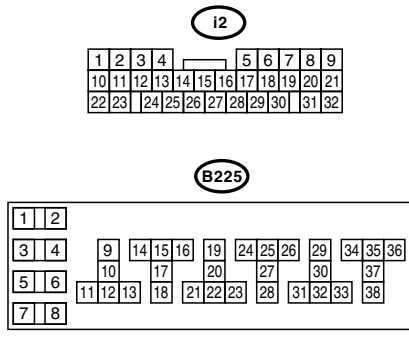
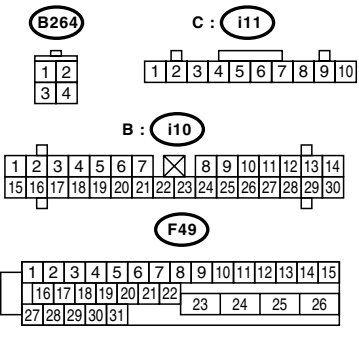
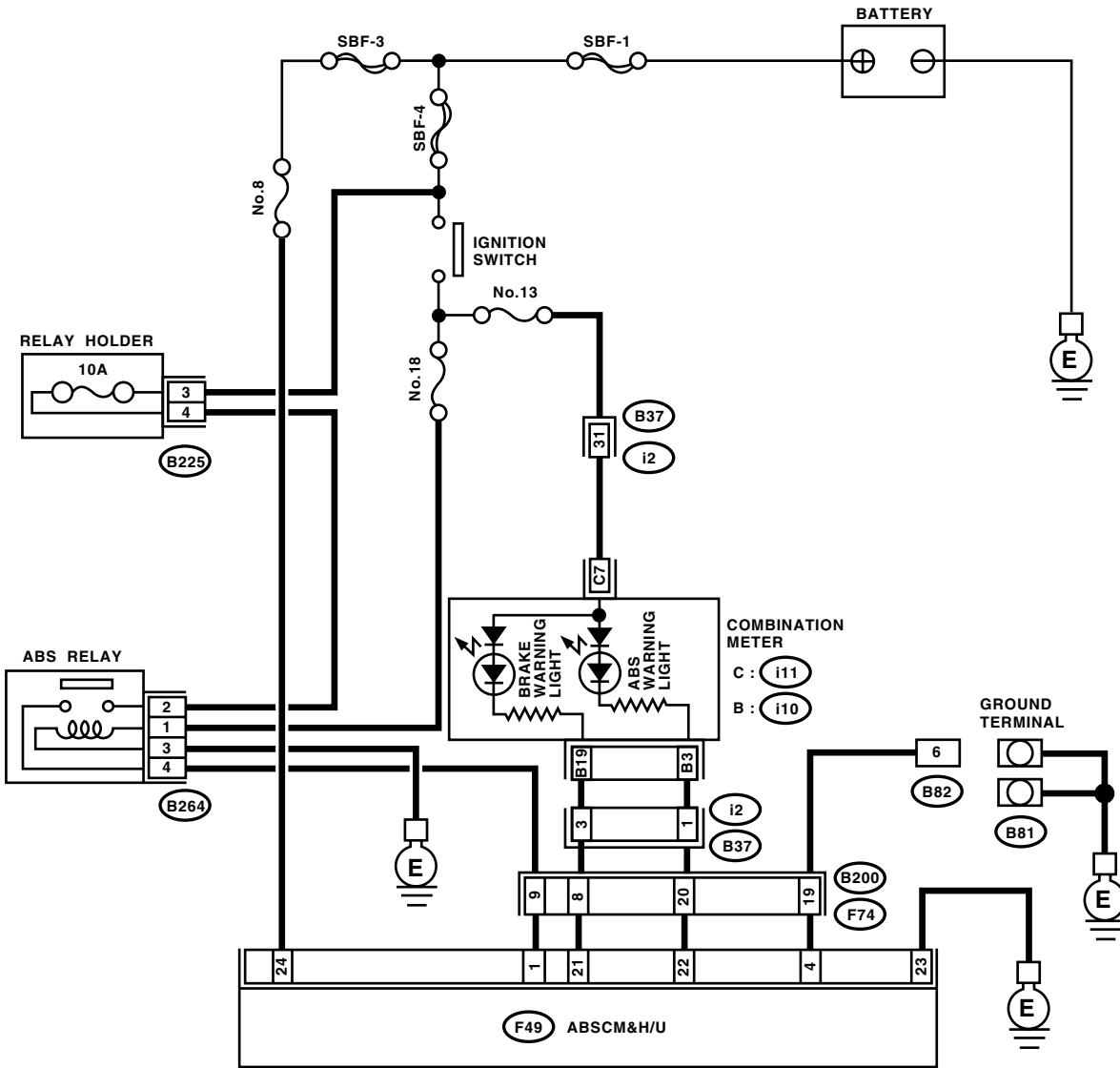

ABS00348

Step	Check	Yes	No
1	<p><b>CHECK INSTALLATION OF ABSCM&amp;H/U CONNECTOR.</b> Turn the ignition switch to OFF.</p>	Go to step 2.	Insert the ABSCM&H/U connector into ABSCM&H/U until the clamp locks onto it.



## Diagnostics Procedure without Diagnostic Trouble Code (DTC)

### ABS (DIAGNOSTICS)

Step	Check	Yes	No
<b>2 CHECK GROUND TERMINAL.</b> Measure the resistance between Ground terminals (B81) and chassis ground. <i>Terminals</i> <i>Ground terminal (A) — Chassis ground:</i> <i>Ground terminal (B) — Chassis ground:</i>	Is the resistance less than 0.5 $\Omega$ ?	Go to step 3.	Repair the open circuit in Ground terminal harness.
<b>3 CHECK DIAGNOSIS LINE.</b> 1)Connect the Ground terminal (B81) to diagnosis connector (B82) No. 6. 2)Disconnect the connector from ABSCM&H/U. 3)Measure the resistance between ABSCM&H/U connector and chassis ground. <i>Connector &amp; terminal</i> <i>LHD: (B301) No. 4 — Chassis ground:</i> <i>RHD: (F49) No. 4 — Chassis ground:</i>	Is the resistance less than 0.5 $\Omega$ ?	Go to step 4.	Repair the open circuit in harness connector between ABSCM&H/U and diagnosis connector.
<b>4 CHECK GENERATOR.</b> 1)Start the engine. 2)Idle the engine. 3)Measure the voltage between generator and chassis ground. <i>Terminals</i> <i>Generator B terminal (+) — Chassis ground (-):</i>	Is the voltage 10 — 15 V?	Go to step 5.	Repair the generator. <Ref. to SC(H4SO)-13, Generator.>
<b>5 CHECK BATTERY TERMINAL.</b> Turn the ignition switch to OFF.	Is there poor contact at battery terminal?	Repair or tighten the battery terminal.	Go to step 6.
<b>6 CHECK POWER SUPPLY OF ABSCM.</b> 1)Start the engine. 2)Idle the engine. 3)Measure the voltage between ABSCM&H/U connector and chassis ground. <i>Connector &amp; terminal</i> <i>LHD: (B301) No. 1 (+) — Chassis ground (-):</i> <i>RHD: (F49) No. 1 (+) — Chassis ground (-):</i>	Is the voltage 10 — 15 V?	Go to step 7.	Repair the ABSCM&H/U power supply circuit.
<b>7 CHECK WIRING HARNESS.</b> 1)Disconnect the connector (i2) from connector (B37). 2)Turn the ignition switch to ON.	Does the ABS warning light turn on?	Repair the front or body wiring harness.	Go to step 8.
<b>8 CHECK PROJECTION AT ABSCM&amp;H/U.</b> 1)Turn the ignition switch to OFF. 2)Check for damage at the ABSCM&H/U terminal. NOTE: For detail of connector switch, refer to following. <Ref. to ABS(diag)-12, ELECTRICAL SPECIFICATION, Control Module I/O Signal.>	Is there any damage on projection which switches connector switch?	Replace the ABSCM only. <Ref. to ABS-6, ABS Control Module and Hydraulic Control Unit (ABSCM&H/U).>	Go to step 9.
<b>9 CHECK ABSCM&amp;H/U.</b> Measure the resistance between ABSCM&H/U terminals. <i>Terminals</i> <i>No. 22 — No. 23:</i>	Is the resistance more than 1 M $\Omega$ ?	Go to step 10.	Replace the ABSCM&H/U. <Ref. to ABS-6, ABS Control Module and Hydraulic Control Unit (ABSCM&H/U).>

# Diagnostics Procedure without Diagnostic Trouble Code (DTC)

ABS (DIAGNOSTICS)

Step	Check	Yes	No
<b>10</b> <b>CHECK WIRING HARNESS.</b> Measure the resistance between connector (B37) and chassis ground. <i><b>Connector &amp; terminal</b></i> <i><b>LHD: (B37) No. 15 — Chassis ground:</b></i> <i><b>RHD: (B37) No. 1 — Chassis ground:</b></i>	Is the resistance less than 0.5 $\Omega$ ?	Go to step 11.	Repair the harness.
<b>11</b> <b>CHECK WIRING HARNESS.</b> 1)Connect the connector to ABSCM&H/U. 2)Measure the resistance between connector (B37) and chassis ground. <i><b>Connector &amp; terminal</b></i> <i><b>LHD: (B37) No. 15 — Chassis ground:</b></i> <i><b>RHD: (B37) No. 1 — Chassis ground:</b></i>	Is the resistance more than 1 M $\Omega$ ?	Go to step 12.	Repair the harness.
<b>12</b> <b>CHECK POOR CONTACT IN ABSCM&amp;H/U CONNECTOR.</b>	Is there poor contact in ABSCM&H/U connector?	Repair the connector.	Replace the ABSCM only. <Ref. to ABS-6, ABS Control Module and Hydraulic Control Unit (ABSCM&H/U).>

# Diagnostics Procedure without Diagnostic Trouble Code (DTC)

ABS (DIAGNOSTICS)

## C: BRAKE WARNING LIGHT DO NOT GO OFF

### DIAGNOSIS:

- Brake warning light circuit is shorted.
- Faulty sensor/connector

### TROUBLE SYMPTOM:

- After starting the engine, brake warning light is kept ON, even if the parking brake lever has been released.

### WIRING DIAGRAM:

LHD MODEL

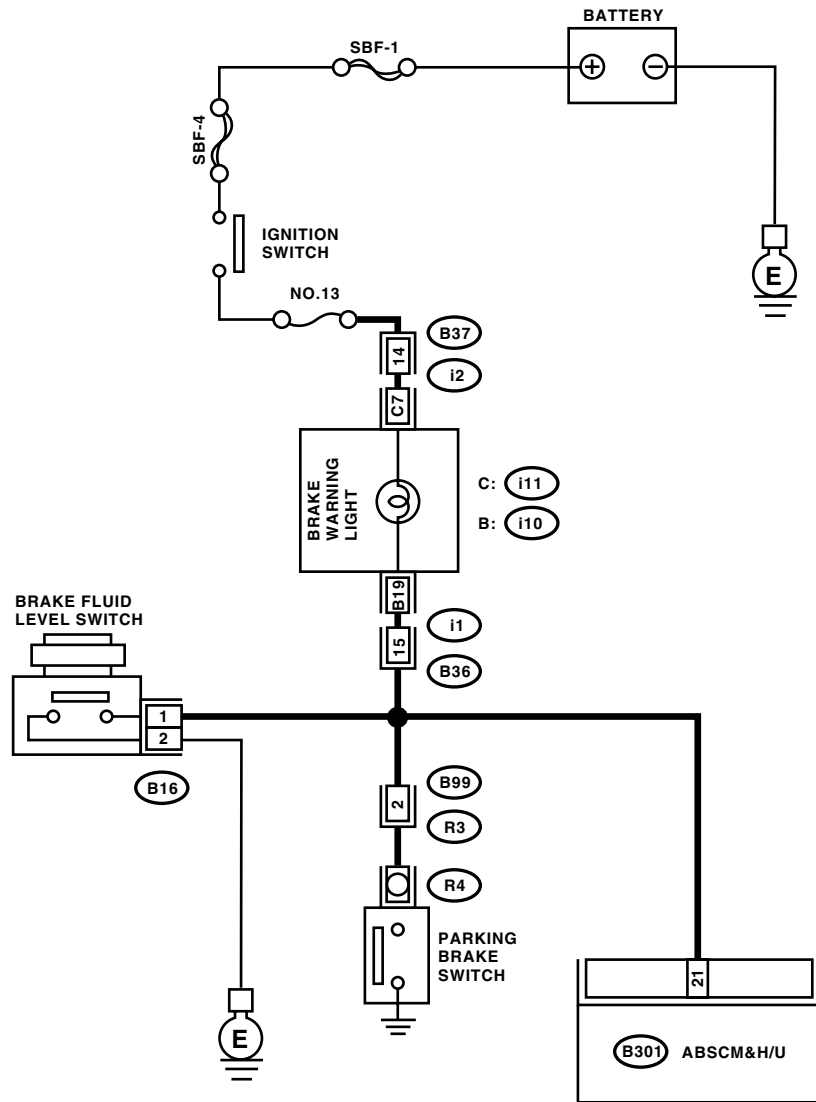

B16



i1

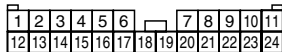

B301

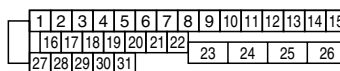

B: i10

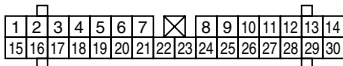

C: i11

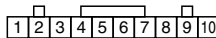

B99 i2



ABS00477

# Diagnostics Procedure without Diagnostic Trouble Code (DTC)

ABS (DIAGNOSTICS)

## RHD MODEL

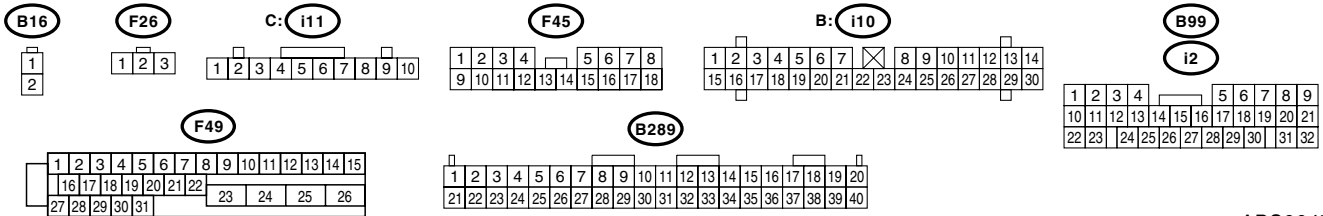
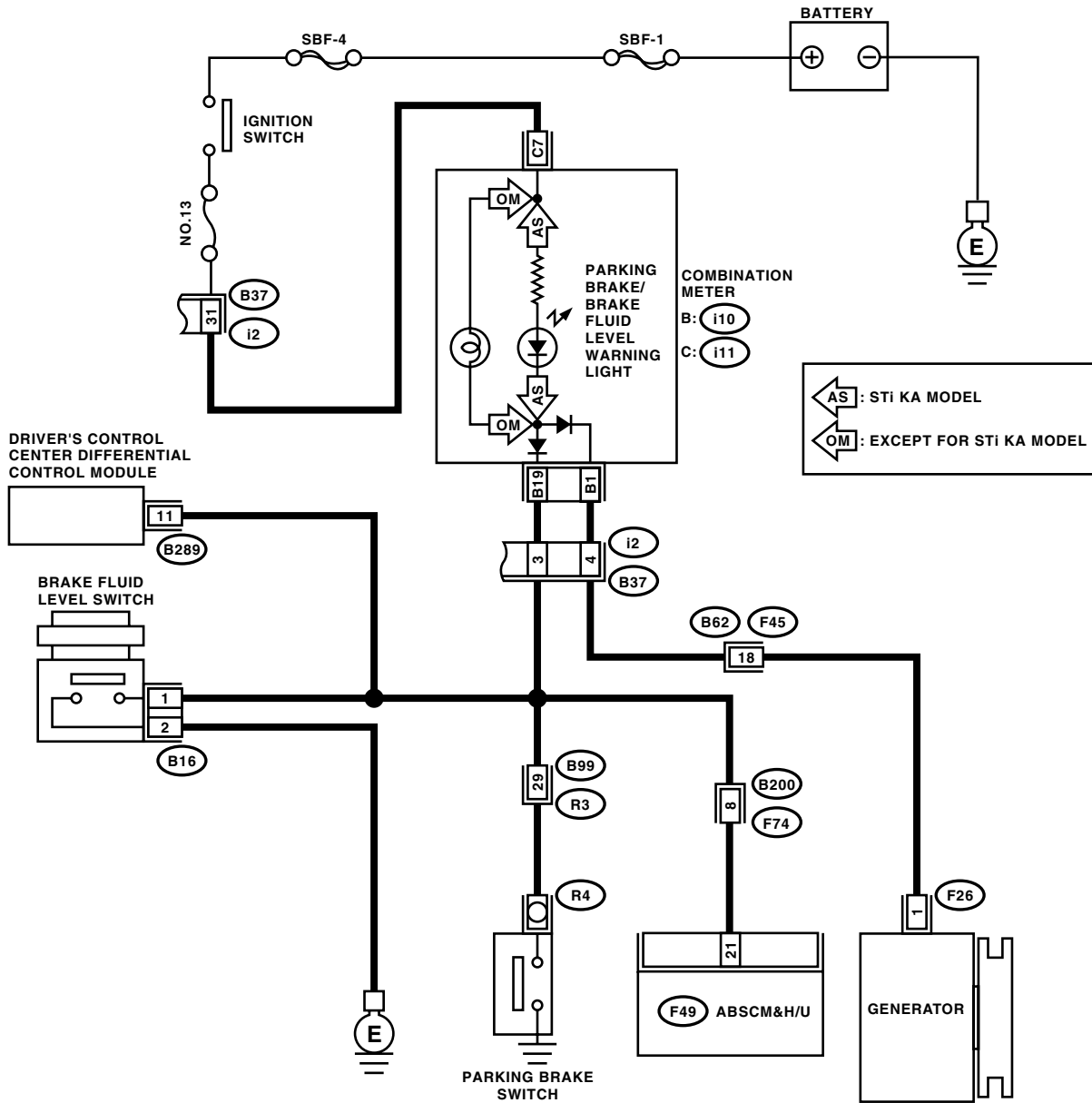

ABS00478

Step	Check	Yes	No
1	<b>CHECK BRAKE FLUID AMOUNT.</b> Check the amount of brake fluid in reservoir tank of master cylinder.	Go to step 2.	Fill the brake fluid to specified amount.

## Diagnostics Procedure without Diagnostic Trouble Code (DTC)

### ABS (DIAGNOSTICS)

Step	Check	Yes	No
<b>2 CHECK BRAKE FLUID LEVEL SWITCH.</b> 1)Disconnect the level switch connector (B16) from master cylinder. 2)Measure the resistance of master cylinder terminals. <b>Terminals</b> <b>No. 1 — No. 2:</b>	Is the resistance more than 1 MΩ?	Go to step 3.	Replace the master cylinder.
<b>3 CHECK PARKING BRAKE SWITCH.</b> 1)Disconnect the connector (R4) from parking brake switch. 2)Release the parking brake switch. 3)Measure the resistance between parking brake switch terminal and chassis ground.	Is the resistance more than 1 MΩ?	Go to step 4.	Replace the parking brake switch.
<b>4 CHECK GROUND SHORT OF HARNESS.</b> 1)Disconnect the connector from ABSCM & H/U. 2)Disconnect the connector (i2) or (i1) from combination meter. 3)Turn the ignition switch to ON.	Does the brake warning light go off?	Go to step 5.	Repair the harness.
<b>5 CHECK POOR CONTACT IN ABSCM &amp; H/U.</b>	Is there poor contact in ABSCM & H/U connector?	Repair the connector.	Replace the ABSCM only. <Ref. to ABS-6, ABS Control Module and Hydraulic Control Unit (ABSCM&H/U).>

## 13. Diagnostics Procedure with Diagnostic Trouble Code (DTC)

### A: COMMUNICATION FOR INITIALIZING IMPOSSIBLE

**DIAGNOSIS:**

- Faulty harness connector

**TROUBLE SYMPTOM:**

- Communication cannot be executed between ABS and Subaru select monitor.

**WIRING DIAGRAM:**

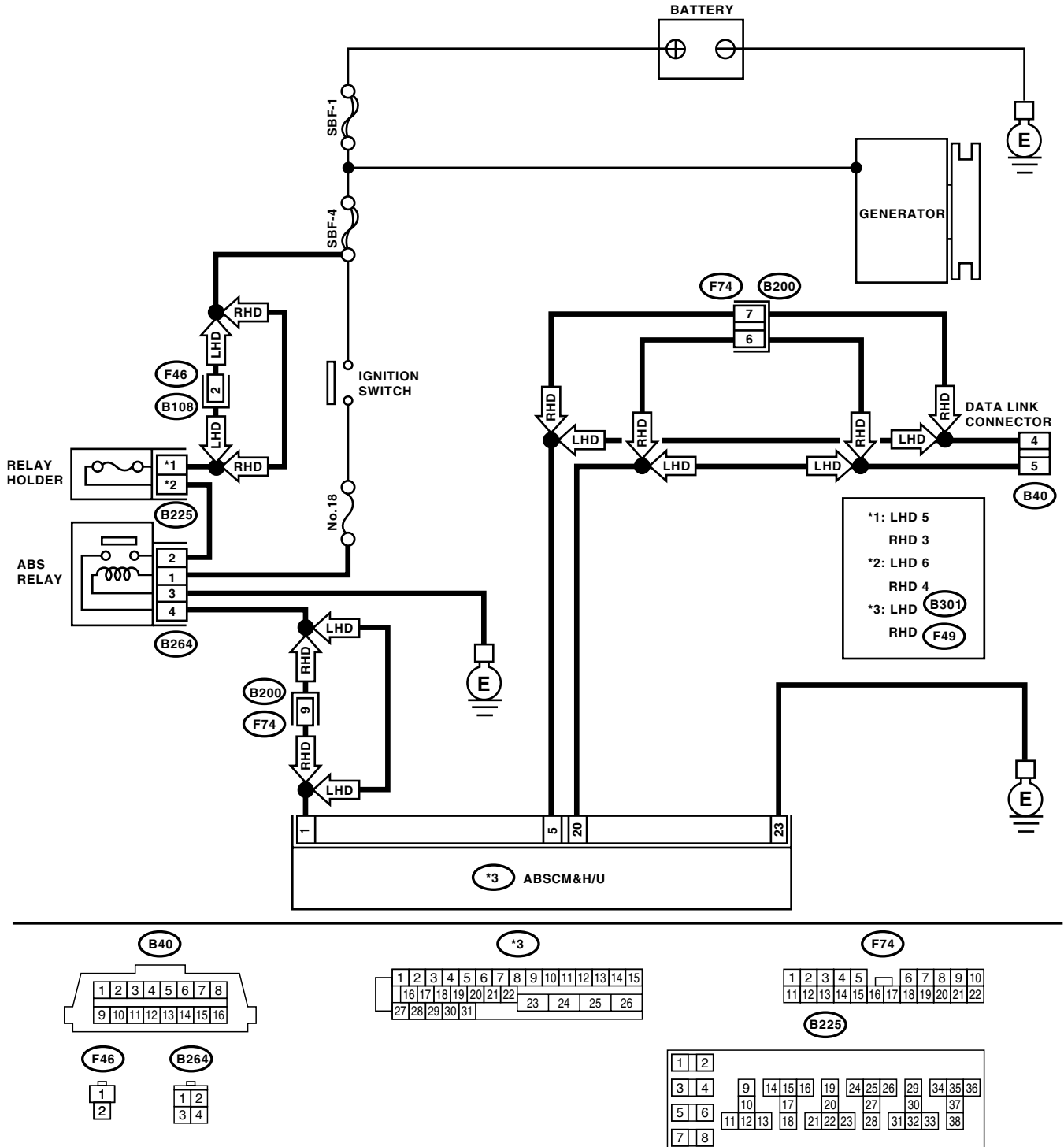

## Diagnostics Procedure with Diagnostic Trouble Code (DTC)

### ABS (DIAGNOSTICS)

Step	Check	Yes	No
<b>1</b>	<b>CHECK IGNITION SWITCH.</b>	Go to step <b>2</b> .	Turn the ignition switch to ON, and select ABS mode using Subaru Select Monitor.
<b>2</b>	<b>CHECK BATTERY.</b> 1) Turn the ignition switch to OFF. 2) Measure the battery voltage.	Go to step <b>3</b> .	Charge or replace the battery.
<b>3</b>	<b>CHECK BATTERY TERMINAL.</b>	Repair or tighten the battery terminal.	Go to step <b>4</b> .
<b>4</b>	<b>CHECK COMMUNICATION OF SUBARU SELECT MONITOR.</b> 1) Turn the ignition switch to ON. 2) Using the Subaru Select Monitor, check whether communication to other system can be executed normally.	Go to step <b>8</b> .	Go to step <b>5</b> .
<b>5</b>	<b>CHECK COMMUNICATION OF SUBARU SELECT MONITOR.</b> 1) Turn the ignition switch to OFF. 2) Disconnect the ABSCM&H/U connector. 3) Turn the ignition switch to ON. 4) Check whether communication to other systems can be executed normally.	Replace the ABSCM only. <Ref. to ABS-6, ABS Control Module and Hydraulic Control Unit (ABSCM&H/U).>	Go to step <b>6</b> .
<b>6</b>	<b>CHECK HARNESS CONNECTOR BETWEEN EACH CONTROL MODULE AND DATA LINK CONNECTOR.</b> 1) Turn the ignition switch to OFF. 2) Disconnect the ABSCM&H/U, ECM and TCM connectors. 3) Measure the resistance between data link connector and chassis ground. <b>Connector &amp; terminal</b> <b>(B40) No. 5 — Chassis ground:</b> <b>(B40) No. 4 — Chassis ground:</b>	Go to step <b>7</b> .	Repair the harness and connector between each control module and data link connector.
<b>7</b>	<b>CHECK OUTPUT SIGNAL FOR ABSCM&amp;H/U.</b> 1) Turn the ignition switch to ON. 2) Measure the voltage between ABSCM&H/U and chassis ground. <b>Connector &amp; terminal</b> <b>(B40) No. 5 (+) — Chassis ground (-):</b> <b>(B40) No. 4 (+) — Chassis ground (-):</b>	Go to step <b>8</b> .	Repair the harness and connector between each control module and data link connector.
<b>8</b>	<b>CHECK HARNESS/CONNECTOR BETWEEN ABSCM&amp;H/U AND DATA LINK CONNECTOR.</b> Measure the resistance between ABSCM&H/U connector and data link connector. <b>Connector &amp; terminal</b> <b>LHD:</b> <b>(B301) No. 20 — (B40) No. 5:</b> <b>(B301) No. 5 — (B40) No. 4:</b> <b>RHD:</b> <b>(F49) No. 20 — (B40) No. 5:</b> <b>(F49) No. 5 — (B40) No. 4:</b>	Go to step <b>9</b> .	Repair the harness and connector between ABSCM&H/U and data link connector.
<b>9</b>	<b>CHECK INSTALLATION OF ABSCM&amp;H/U CONNECTOR.</b> Turn the ignition switch to OFF.	Go to step <b>10</b> .	Insert the ABSCM&H/U connector into ABSCM&H/U.

# Diagnostics Procedure with Diagnostic Trouble Code (DTC)

ABS (DIAGNOSTICS)

Step	Check	Yes	No
<b>10 CHECK POWER SUPPLY CIRCUIT.</b> 1) Turn the ignition switch to ON (engine OFF). 2) Measure the ignition power supply voltage between ABSCM&H/U connector and chassis ground. <i>Connector &amp; terminal</i> <i>LHD: (B301) No. 1 (+) — Chassis ground (-):</i> <i>RHD: (F49) No. 1 (+) — Chassis ground (-):</i>	Is the voltage 10 — 15 V?	Go to step 11.	Repair the open circuit in harness between ABSCM&H/U and battery.
<b>11 CHECK HARNESS CONNECTOR BETWEEN ABSCM&amp;H/U AND CHASSIS GROUND.</b> 1) Turn the ignition switch to OFF. 2) Disconnect the connector from ABSCM&H/U and transmission. 3) Measure the resistance of harness between ABSCM&H/U and chassis ground. <i>Connector &amp; terminal</i> <i>LHD: (B301) No. 23 — Chassis ground:</i> <i>RHD: (F49) No. 23 — Chassis ground:</i>	Is the resistance less than 0.5 $\Omega$ ?	Go to step 12.	Repair the open circuit in harness between ABSCM&H/U and inhibitor side connector, and poor contact in coupling connector.
<b>12 CHECK POOR CONTACT IN CONNECTORS.</b>	Is there poor contact in control module power supply, ground line and data link connector?	Repair the connector.	Replace the ABSCM only. <Ref. to ABS-6, ABS Control Module and Hydraulic Control Unit (ABSCM&H/U).>



## **Diagnostics Procedure with Diagnostic Trouble Code (DTC)**

ABS (DIAGNOSTICS)

---

### **B: NO DTC**

#### **DIAGNOSIS:**

- ABS warning light circuit is shorted.

#### **TROUBLE SYMPTOM:**

- ABS warning light remains on.
- NO DTC displayed on the Subaru Select Monitor.

#### **NOTE:**

When the ABS warning light is OFF and "NO DTC" is displayed on Subaru Select Monitor, the system is in normal condition.

# Diagnostics Procedure with Diagnostic Trouble Code (DTC)

ABS (DIAGNOSTICS)

## WIRING DIAGRAM: LHD MODEL

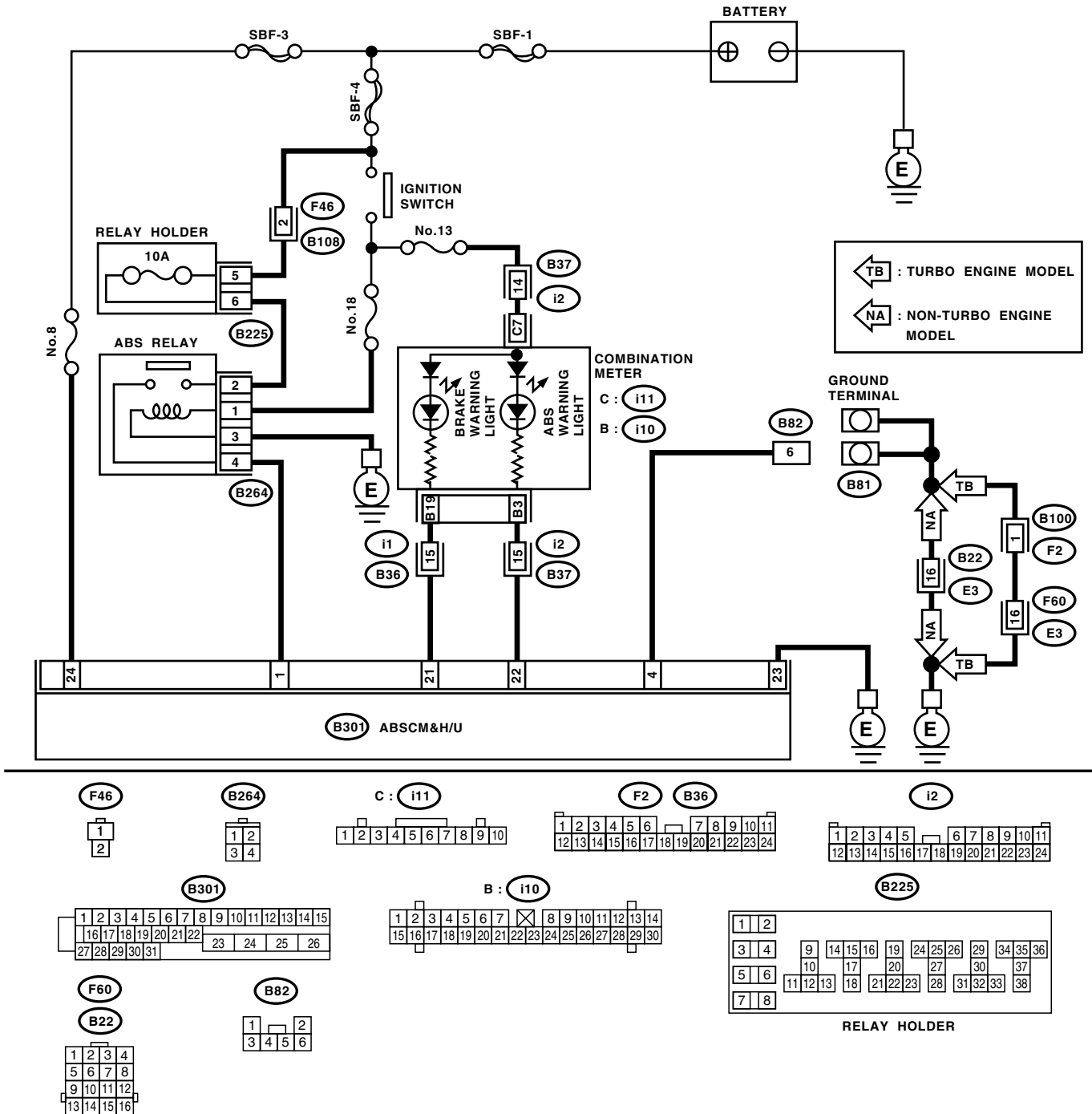

ABS00347

# Diagnostics Procedure with Diagnostic Trouble Code (DTC)

ABS (DIAGNOSTICS)

RHD MODEL

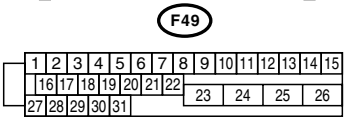
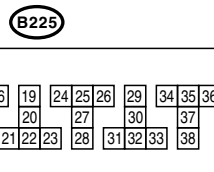
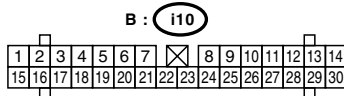
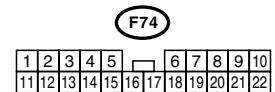
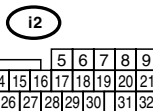
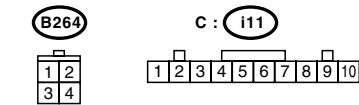
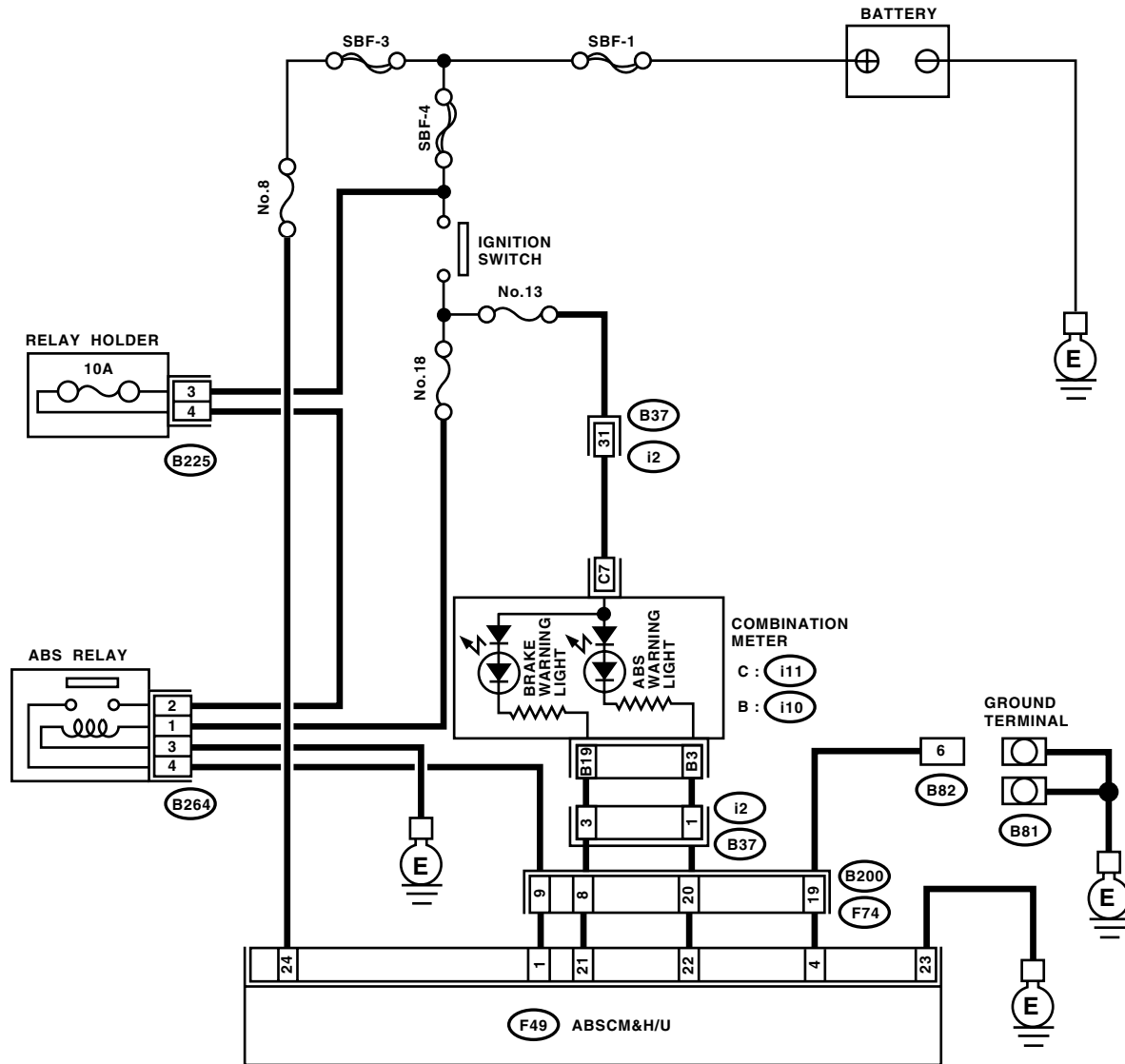

ABS00348

Step	Check	Yes	No
1	<p><b>CHECK WIRING HARNESS.</b></p> <p>1) Turn the ignition switch to OFF.</p> <p>2) Disconnect the connector (i2) from connector (B37).</p> <p>3) Turn the ignition switch to ON.</p>	Go to step 2.	Repair the front wiring harness.

# Diagnostics Procedure with Diagnostic Trouble Code (DTC)

ABS (DIAGNOSTICS)

Step	Check	Yes	No
<b>2 CHECK PROJECTION AT ABSCM&amp;H/U.</b> 1) Turn the ignition switch to OFF. 2) Disconnect the connector from ABSCM&H/U.  NOTE: For detail of connector switch, refer to following. <Ref. to ABS(diag)-12, ELECTRICAL SPECIFICATION, Control Module I/O Signal.>	Is there any damage on projection which switches connector switch?	Go to step 3.	Replace the ABSCM&H/U. <Ref. to ABS-6, ABS Control Module and Hydraulic Control Unit (ABSCM&H/U).>
<b>3 CHECK ABSCM&amp;H/U.</b> Measure the resistance between ABSCM&H/U terminals.  <i><b>Terminals</b></i> <i><b>No. 22 — No. 23:</b></i>	Is the resistance more than 1 MΩ?	Go to step 4.	Replace the ABSCM&H/U. <Ref. to ABS-6, ABS Control Module and Hydraulic Control Unit (ABSCM&H/U).>
<b>4 CHECK WIRING HARNESS.</b> Measure the resistance between connector and chassis ground.  <i><b>Connector &amp; terminal</b></i> <i><b>LHD: (B301) No. 22 — Chassis ground:</b></i> <i><b>RHD: (F49) No. 22 — Chassis ground:</b></i>	Is the resistance less than 0.5 Ω?	Go to step 5.	Repair the harness.
<b>5 CHECK WIRING HARNESS.</b> 1) Connect the connector to ABSCM&H/U. 2) Measure the resistance between connector and chassis ground.  <i><b>Connector &amp; terminal</b></i> <i><b>LHD: (B301) No. 22 — Chassis ground:</b></i> <i><b>RHD: (F49) No. 22 — Chassis ground:</b></i>	Is the resistance more than 1 MΩ?	Go to step 6.	Repair the harness.
<b>6 CHECK POOR CONTACT IN ABSCM&amp;H/U CONNECTOR.</b>	Is there poor contact in ABSCM&H/U connector?	Repair the connector.	Replace the ABSCM&H/U. <Ref. to ABS-6, ABS Control Module and Hydraulic Control Unit (ABSCM&H/U).>

## C: DTC 21 OPEN OR SHORT CIRCUIT IN FRONT RIGHT ABS WHEEL SPEED SENSOR CIRCUIT

NOTE:

For the diagnostic procedure, refer to DTC 27. <Ref. to ABS(diag)-44, DTC 27 OPEN OR SHORT CIRCUIT IN REAR LEFT ABS WHEEL SPEED SENSOR CIRCUIT, Diagnostics Procedure with Diagnostic Trouble Code (DTC).>

## D: DTC 23 OPEN OR SHORT CIRCUIT IN FRONT LEFT ABS WHEEL SPEED SENSOR CIRCUIT

NOTE:

For the diagnostic procedure, refer to DTC 27. <Ref. to ABS(diag)-44, DTC 27 OPEN OR SHORT CIRCUIT IN REAR LEFT ABS WHEEL SPEED SENSOR CIRCUIT, Diagnostics Procedure with Diagnostic Trouble Code (DTC).>

## E: DTC 25 OPEN OR SHORT CIRCUIT IN REAR RIGHT ABS WHEEL SPEED SENSOR CIRCUIT

NOTE:

For the diagnostic procedure, refer to DTC 27. <Ref. to ABS(diag)-44, DTC 27 OPEN OR SHORT CIRCUIT IN REAR LEFT ABS WHEEL SPEED SENSOR CIRCUIT, Diagnostics Procedure with Diagnostic Trouble Code (DTC).>

## **Diagnostics Procedure with Diagnostic Trouble Code (DTC)**

ABS (DIAGNOSTICS)

---

### **F: DTC 27 OPEN OR SHORT CIRCUIT IN REAR LEFT ABS WHEEL SPEED SENSOR CIRCUIT**

#### **DIAGNOSIS:**

- Faulty ABS wheel speed sensor (Broken wire, input voltage too high)
- Faulty harness connector

#### **TROUBLE SYMPTOM:**

- ABS does not operate.

# Diagnostics Procedure with Diagnostic Trouble Code (DTC)

ABS (DIAGNOSTICS)

## WIRING DIAGRAM: LHD MODEL

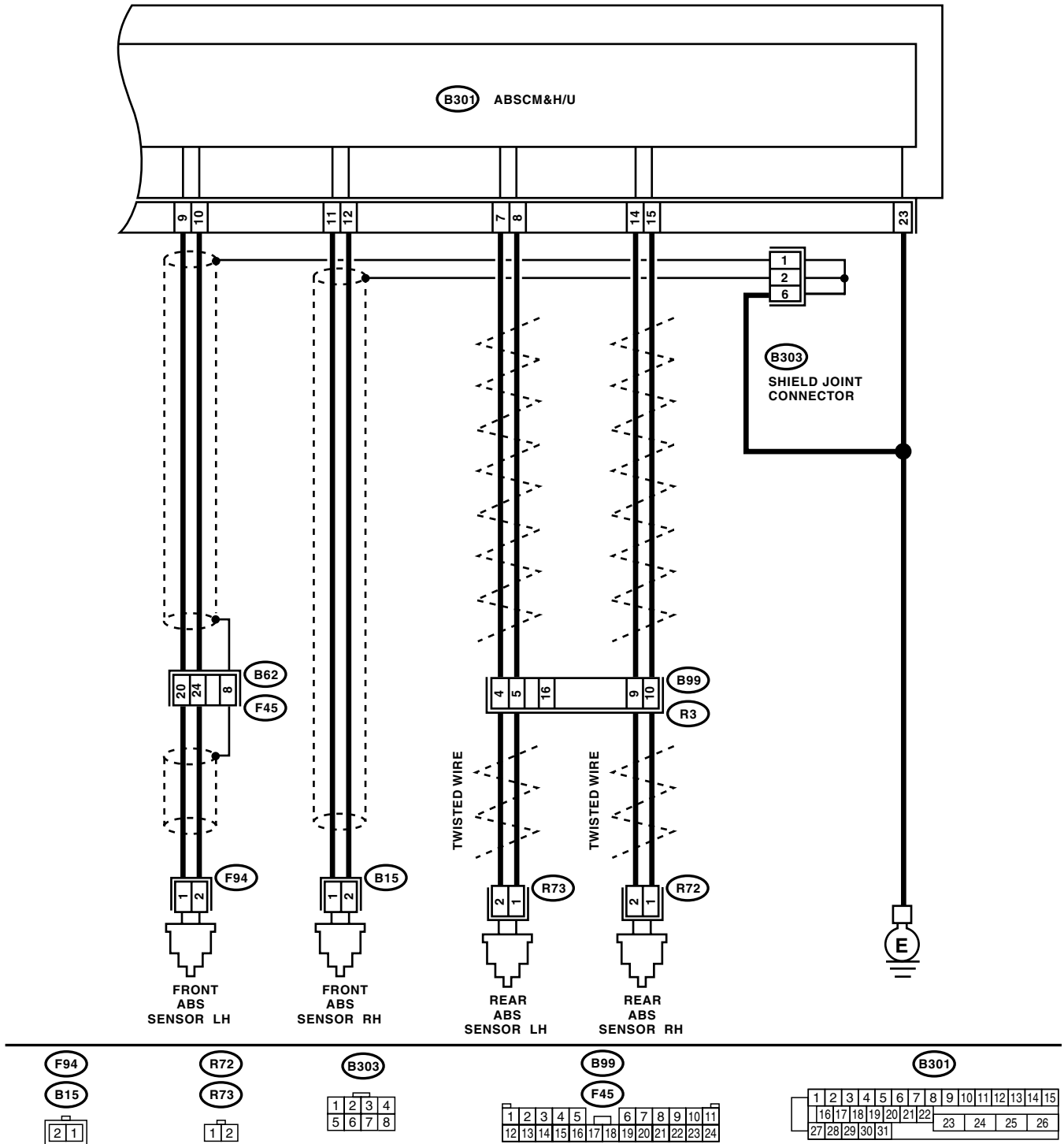

ABS00353

# Diagnostics Procedure with Diagnostic Trouble Code (DTC)

ABS (DIAGNOSTICS)

RHD MODEL

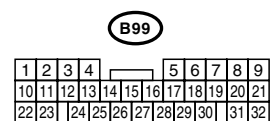
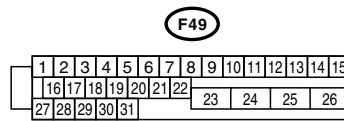
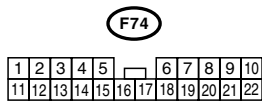
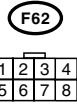
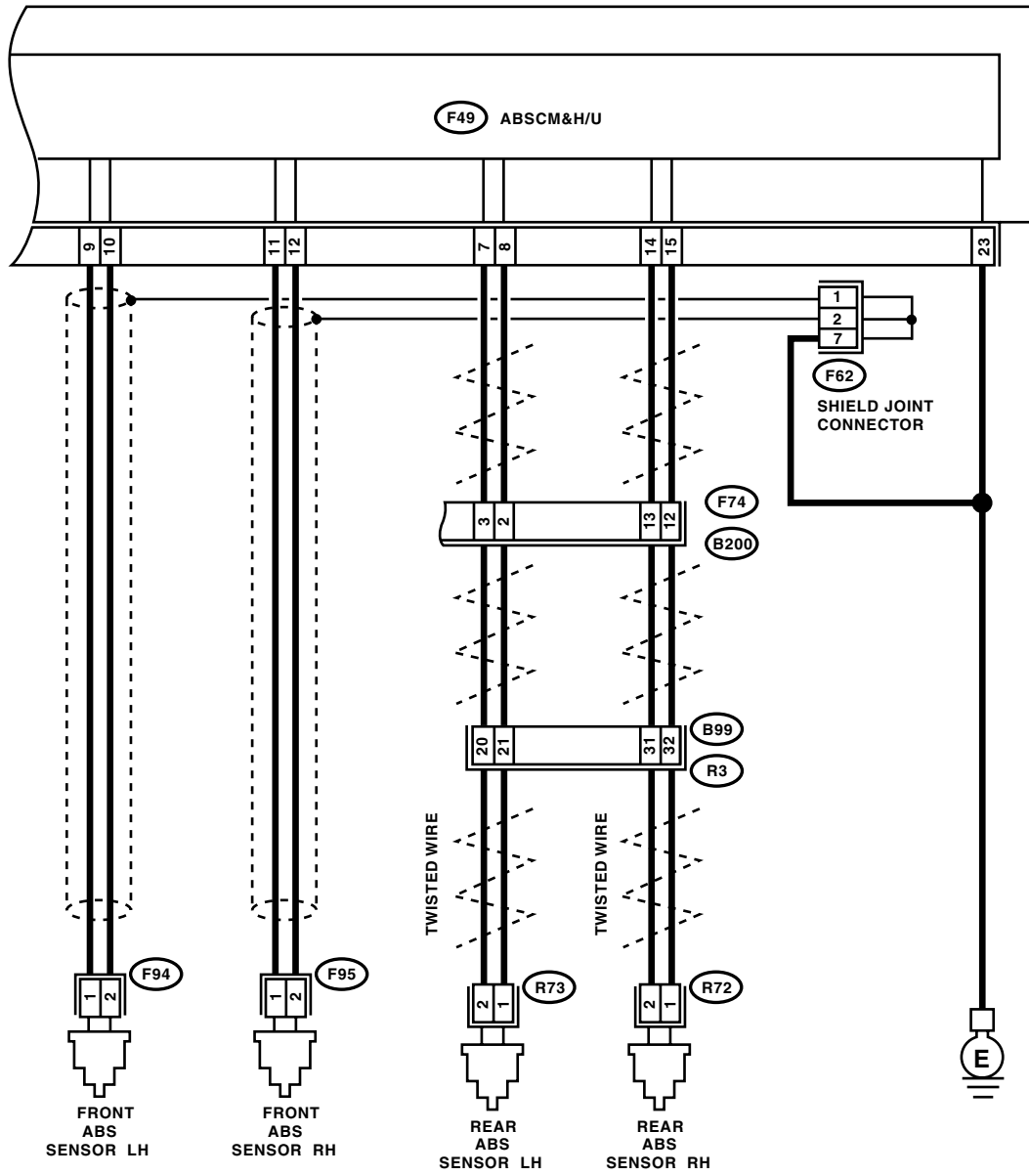

ABS00354

# Diagnostics Procedure with Diagnostic Trouble Code (DTC)

ABS (DIAGNOSTICS)

Step	Check	Yes	No	
1	<b>CHECK OUTPUT OF ABS WHEEL SPEED SENSOR USING SUBARU SELECT MONITOR.</b> 1)Select "Current data display & Save" on the Subaru Select Monitor. 2)Read the ABS wheel speed sensor output corresponding to faulty system in the Subaru Select Monitor data display mode.	Does the speed indicated on display change in response to speedometer reading during acceleration/deceleration when the steering wheel is in straight-ahead position?	Go to step 2.	Go to step 8.
2	<b>CHECK INSTALLATION OF ABS WHEEL SPEED SENSOR.</b>	Are the ABS wheel speed sensor installation bolts tightened 33 N·m (3.3 kgf·m, 24 ft·lb)?	Go to step 3.	Tighten the ABS wheel speed sensor installation bolts securely.
3	<b>CHECK ABS WHEEL SPEED SENSOR GAP.</b> Measure the tone wheel to ABS wheel speed sensor piece gap over entire perimeter of the wheel.	Is the gap as following value? Front wheel: 0.3 — 0.8 mm (0.012 — 0.031 in) Rear wheel 0.7 — 1.2 mm (0.028 — 0.047 in)	Go to step 4.	Adjust the gap. NOTE: Adjust the gap using spacers (Part No. 26755AA000). If the spacers cannot correct gap, replace worn sensor or worn tone wheel.
4	<b>CHECK TONE WHEEL RUNOUT.</b> Measure the tone wheel runout.	Is the runout less than 0.05 mm (0.0020 in)?	Go to step 5.	Replace the tone wheel. Front: <Ref. to ABS-19, Front Tone Wheel.> Rear: <Ref. to ABS-20, Rear Tone Wheel.>
5	<b>CHECK POOR CONTACT IN CONNECTORS.</b> Turn the ignition switch to OFF.	Is there poor contact in connectors between ABSCM&H/U and ABS wheel speed sensor?	Repair the connector.	Go to step 6.
6	<b>CHECK ABSCM&amp;H/U.</b> 1)Connect all connectors. 2)Erase the memory. 3)Perform the inspection mode. 4)Read out the DTC.	Is the same DTC as in the current diagnosis still being output?	Replace the ABSCM only. <Ref. to ABS-6, ABS Control Module and Hydraulic Control Unit (ABSCM&H/U).>	Go to step 7.
7	<b>CHECK ANY OTHER DTC APPEARANCE.</b>	Are other DTCs being output?	Proceed with the diagnosis corresponding to DTC.	A temporary poor contact. NOTE: Check the harness and connectors between ABSCM&H/U and ABS wheel speed sensor.



# Diagnostics Procedure with Diagnostic Trouble Code (DTC)

## ABS (DIAGNOSTICS)

Step	Check	Yes	No
<b>8 CHECK ABS WHEEL SPEED SENSOR.</b> 1) Turn the ignition switch to OFF. 2) Disconnect the connector from ABS wheel speed sensor. 3) Measure the resistance of ABS wheel speed sensor connector terminals while shaking the harness lightly. <b>Terminals</b> <i>Front RH No. 1 — No. 2:</i> <i>Front LH No. 1 — No. 2:</i> <i>Rear RH No. 1 — No. 2:</i> <i>Rear LH No. 1 — No. 2:</i>	Is the resistance as following value? Front: 1 — 1.5 kΩ Rear: 1.025 — 1.265 kΩ	Go to step 9.	Replace the ABS wheel speed sensor. Front: <Ref. to ABS-13, Front ABS Wheel Speed Sensor.> Rear: <Ref. to ABS-16, Rear ABS Wheel Speed Sensor.>
<b>9 CHECK BATTERY SHORT OF ABS WHEEL SPEED SENSOR.</b> 1) Disconnect the connector from ABSCM&H/U. 2) Measure the voltage between ABS wheel speed sensor and chassis ground. <b>Terminals</b> <i>Front RH No. 1 (+) — Chassis ground (-):</i> <i>Front LH No. 1 (+) — Chassis ground (-):</i> <i>Rear RH No. 1 (+) — Chassis ground (-):</i> <i>Rear LH No. 1 (+) — Chassis ground (-):</i>	Is the voltage less than 1 V?	Go to step 10.	Replace the ABS wheel speed sensor. Front: <Ref. to ABS-13, Front ABS Wheel Speed Sensor.> Rear: <Ref. to ABS-16, Rear ABS Wheel Speed Sensor.>
<b>10 CHECK BATTERY SHORT OF ABS WHEEL SPEED SENSOR.</b> 1) Turn the ignition switch to ON. 2) Measure the voltage between ABS wheel speed sensor and chassis ground. <b>Terminals</b> <i>Front RH No. 1 (+) — Chassis ground (-):</i> <i>Front LH No. 1 (+) — Chassis ground (-):</i> <i>Rear RH No. 1 (+) — Chassis ground (-):</i> <i>Rear LH No. 1 (+) — Chassis ground (-):</i>	Is the voltage less than 1 V?	Go to step 11.	Replace the ABS wheel speed sensor. Front: <Ref. to ABS-13, Front ABS Wheel Speed Sensor.> Rear: <Ref. to ABS-16, Rear ABS Wheel Speed Sensor.>
<b>11 CHECK HARNESS/CONNECTOR BETWEEN ABSCM&amp;H/U AND ABS WHEEL SPEED SENSOR.</b> 1) Turn the ignition switch to OFF. 2) Connect the connector to ABS wheel speed sensor. 3) Measure the resistance between ABSCM&H/U connector terminals. <b>Connector &amp; terminal</b> <b>DTC 21</b> <i>LHD: (B301) No. 11 — No. 12:</i> <i>RHD: (F49) No. 11 — No. 12:</i> <b>DTC 23</b> <i>LHD: (B301) No. 9 — No. 10:</i> <i>RHD: (F49) No. 9 — No. 10:</i> <b>DTC 25</b> <i>LHD: (B301) No. 14 — No. 15:</i> <i>RHD: (F49) No. 14 — No. 15:</i> <b>DTC 27</b> <i>LHD: (B301) No. 7 — No. 8:</i> <i>RHD: (F49) No. 7 — No. 8:</i>	Is the resistance as following value? Front: 1 — 1.5 kΩ Rear: 1.025 — 1.265 kΩ	Go to step 12.	Repair the harness/connector between ABSCM&H/U and ABS wheel speed sensor.

# Diagnostics Procedure with Diagnostic Trouble Code (DTC)

ABS (DIAGNOSTICS)

Step	Check	Yes	No
<p><b>12</b>    <b>CHECK BATTERY SHORT OF HARNESS.</b>                      Measure the voltage between ABSCM&amp;H/U connector and chassis ground.  <i>Connector &amp; terminal</i>  <b>DTC 21</b>  <i>LHD: (B301) No. 11 (+) — Chassis ground (-):</i>  <i>RHD: (F49) No. 11 (+) — Chassis ground (-):</i>  <b>DTC 23</b>  <i>LHD: (B301) No. 9 (+) — Chassis ground (-):</i>  <i>RHD: (F49) No. 9 (+) — Chassis ground (-):</i>  <b>DTC 25</b>  <i>LHD: (B301) No. 14 (+) — Chassis ground (-):</i>  <i>RHD: (F49) No. 14 (+) — Chassis ground (-):</i>  <b>DTC 27</b>  <i>LHD: (B301) No. 7 (+) — Chassis ground (-):</i>  <i>RHD: (F49) No. 7 (+) — Chassis ground (-):</i></p>	<p>Is the voltage less than 1 V?</p>	<p>Go to step <b>13</b>.</p>	<p>Repair the harness between ABSCM&amp;H/U and ABS wheel speed sensor.</p>
<p><b>13</b>    <b>CHECK BATTERY SHORT OF HARNESS.</b>                      1) Turn the ignition switch to ON.                      2) Measure the voltage between ABSCM&amp;H/U connector and chassis ground.  <i>Connector &amp; terminal</i>  <b>DTC 21</b>  <i>LHD: (B301) No. 11 (+) — Chassis ground (-):</i>  <i>RHD: (F49) No. 11 (+) — Chassis ground (-):</i>  <b>DTC 23</b>  <i>LHD: (B301) No. 9 (+) — Chassis ground (-):</i>  <i>RHD: (F49) No. 9 (+) — Chassis ground (-):</i>  <b>DTC 25</b>  <i>LHD: (B301) No. 14 (+) — Chassis ground (-):</i>  <i>RHD: (F49) No. 14 (+) — Chassis ground (-):</i>  <b>DTC 27</b>  <i>LHD: (B301) No. 7 (+) — Chassis ground (-):</i>  <i>RHD: (F49) No. 7 (+) — Chassis ground (-):</i></p>	<p>Is the voltage less than 1 V?</p>	<p>Go to step <b>14</b>.</p>	<p>Repair the harness between ABSCM&amp;H/U and ABS wheel speed sensor.</p>
<p><b>14</b>    <b>CHECK INSTALLATION OF ABS WHEEL SPEED SENSOR.</b></p>	<p>Are the ABS wheel speed sensor installation bolts tightened 33 N·m (3.3 kgf·m, 24 ft·lb)?</p>	<p>Go to step <b>15</b>.</p>	<p>Tighten the ABS wheel speed sensor installation bolts securely.</p>

# Diagnostics Procedure with Diagnostic Trouble Code (DTC)

## ABS (DIAGNOSTICS)

Step	Check	Yes	No
<b>15 CHECK ABS WHEEL SPEED SENSOR GAP.</b> Measure the tone wheel to ABS wheel speed sensor piece gap over entire perimeter of the wheel.	Is the gap as following value? Front wheel: 0.3 — 0.8 mm (0.012 — 0.031 in) Rear wheel: 0.7 — 1.2 mm (0.028 — 0.047 in)	Go to step 16.	Adjust the gap. NOTE: Adjust the gap using spacers (Part No. 26755AA000). If the spacers cannot correct gap, replace worn sensor or worn tone wheel.
<b>16 CHECK TONE WHEEL RUNOUT.</b> Measure the tone wheel runout.	Is the runout less than 0.05 mm (0.0020 in)?	Go to step 17.	Replace the tone wheel. Front: <Ref. to ABS-19, Front Tone Wheel.> Rear: <Ref. to ABS-20, Rear Tone Wheel.>
<b>17 CHECK GROUND SHORT OF ABS WHEEL SPEED SENSOR.</b> 1) Turn the ignition switch to ON. 2) Measure the resistance between ABS wheel speed sensor and chassis ground. <b>Terminals</b> <i>Front RH No. 1 — Chassis ground:</i> <i>Front LH No. 1 — Chassis ground:</i> <i>Rear RH No. 1 — Chassis ground:</i> <i>Rear LH No. 1 — Chassis ground:</i>	Is the resistance more than 1 M $\Omega$ ?	Go to step 18.	Replace the ABS wheel speed sensor and ABSCM&H/U. Front: <Ref. to ABS-13, Front ABS Wheel Speed Sensor.> Rear: <Ref. to ABS-16, Rear ABS Wheel Speed Sensor.> and <Ref. to ABS-6, ABS Control Module and Hydraulic Control Unit (ABSCM&H/U).>
<b>18 CHECK GROUND SHORT OF HARNESS.</b> 1) Turn the ignition switch to OFF. 2) Connect the connector to ABS wheel speed sensor. 3) Measure the resistance between ABSCM&H/U connector terminal and chassis ground. <b>Connector &amp; terminal</b> <b>DTC 21</b> <i>LHD: (B301) No. 11 — Chassis ground:</i> <i>RHD: (F49) No. 11 — Chassis ground:</i> <b>DTC 23</b> <i>LHD: (B301) No. 9 — Chassis ground:</i> <i>RHD: (F49) No. 9 — Chassis ground:</i> <b>DTC 25</b> <i>LHD: (B301) No. 14 — Chassis ground:</i> <i>RHD: (F49) No. 14 — Chassis ground:</i> <b>DTC 27</b> <i>LHD: (B301) No. 7 — Chassis ground:</i> <i>RHD: (F49) No. 7 — Chassis ground:</i>	Is the resistance more than 1 M $\Omega$ ?	Go to step 19.	Repair the harness between ABSCM&H/U and ABS wheel speed sensor. And replace the ABSCM&H/U. <Ref. to ABS-6, ABS Control Module and Hydraulic Control Unit (ABSCM&H/U).>
<b>19 CHECK POOR CONTACT IN CONNECTORS.</b>	Is there poor contact in connectors between ABSCM&H/U and ABS wheel speed sensor?	Repair the connector.	Go to step 20.

# Diagnosics Procedure with Diagnostic Trouble Code (DTC)

ABS (DIAGNOSTICS)

Step	Check	Yes	No
<b>20</b> <b>CHECK ABSCM&amp;H/U.</b> 1)Connect all connectors. 2)Erase the memory. 3)Perform the inspection mode. 4)Read out the DTC.	Is the same DTC as in current diagnosis still being output?	Replace the ABSCM only.	Go to step <b>21</b> .
<b>21</b> <b>CHECK ANY OTHER DTC APPEARANCE.</b>	Are other DTCs being output?	Proceed with the diagnosis corresponding to DTC.	A temporary poor contact. NOTE: Check the harness and connectors between AB-SCM&H/U and ABS wheel speed sensor.

## **G: DTC 22 FRONT RIGHT ABNORMAL ABS WHEEL SPEED SENSOR SIGNAL**

NOTE:

For the diagnostic procedure, refer to DTC 28. <Ref. to ABS(diag)-52, DTC 28 REAR LEFT ABNORMAL ABS WHEEL SPEED SENSOR SIGNAL, Diagnosics Procedure with Diagnostic Trouble Code (DTC).>

## **H: DTC 24 FRONT LEFT ABNORMAL ABS WHEEL SPEED SENSOR SIGNAL**

NOTE:

For the diagnostic procedure, refer to DTC 28. <Ref. to ABS(diag)-52, DTC 28 REAR LEFT ABNORMAL ABS WHEEL SPEED SENSOR SIGNAL, Diagnosics Procedure with Diagnostic Trouble Code (DTC).>

## **I: DTC 26 REAR RIGHT ABNORMAL ABS WHEEL SPEED SENSOR SIGNAL**

NOTE:

For the diagnostic procedure, refer to DTC 28. <Ref. to ABS(diag)-52, DTC 28 REAR LEFT ABNORMAL ABS WHEEL SPEED SENSOR SIGNAL, Diagnosics Procedure with Diagnostic Trouble Code (DTC).>

# Diagnostics Procedure with Diagnostic Trouble Code (DTC)

ABS (DIAGNOSTICS)

## J: DTC 28 REAR LEFT ABNORMAL ABS WHEEL SPEED SENSOR SIGNAL

### DIAGNOSIS:

- Faulty ABS wheel speed sensor signal (noise, irregular signal, etc.)
- Faulty harness/connector

### TROUBLE SYMPTOM:

- ABS does not operate.

### WIRING DIAGRAM:

LHD MODEL

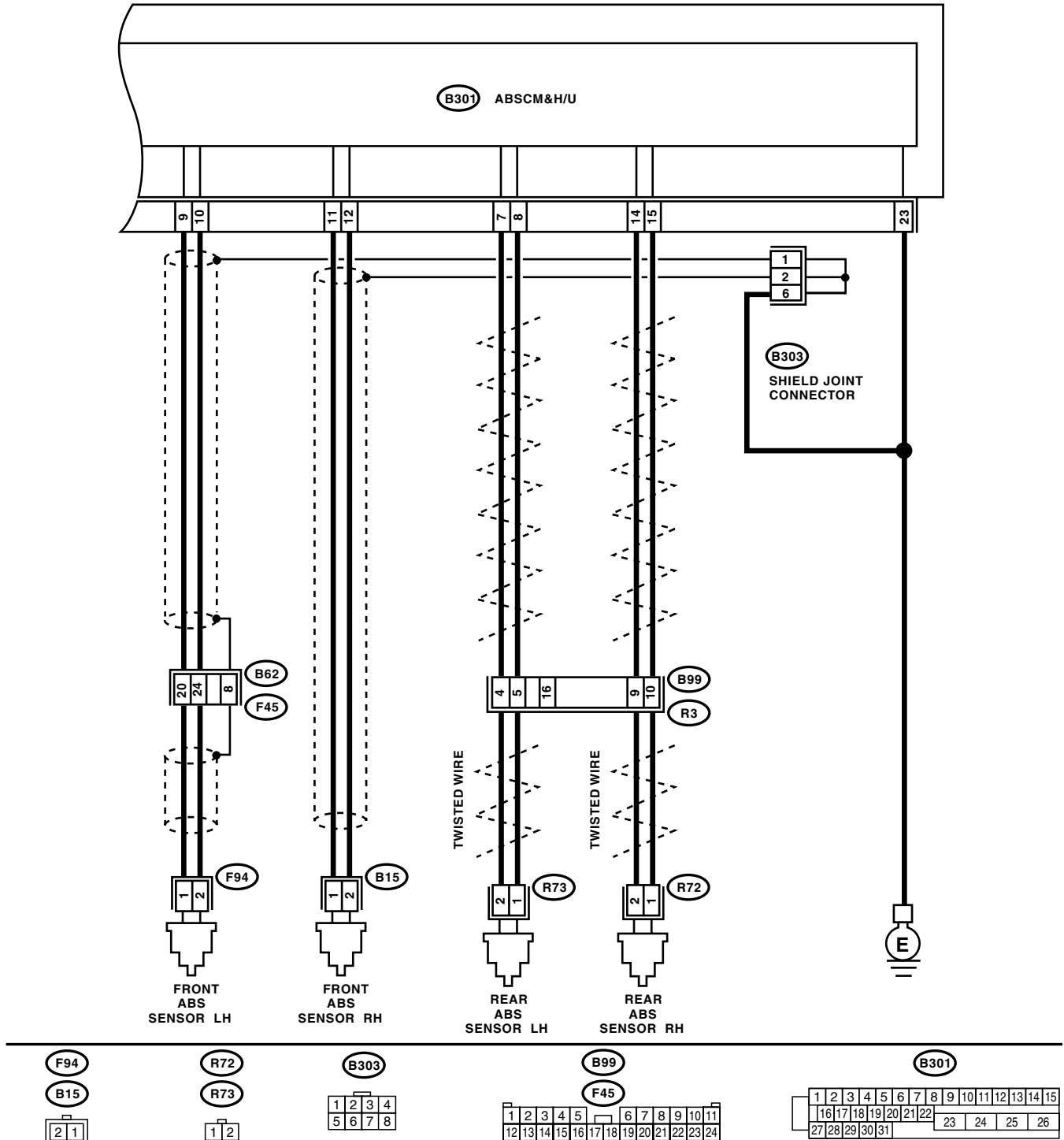

ABS00353

# Diagnostics Procedure with Diagnostic Trouble Code (DTC)

ABS (DIAGNOSTICS)

RHD MODEL

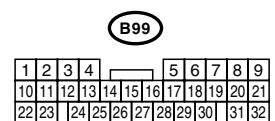
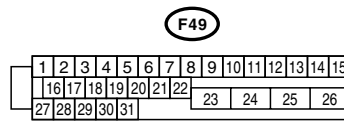
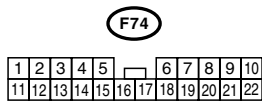
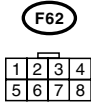
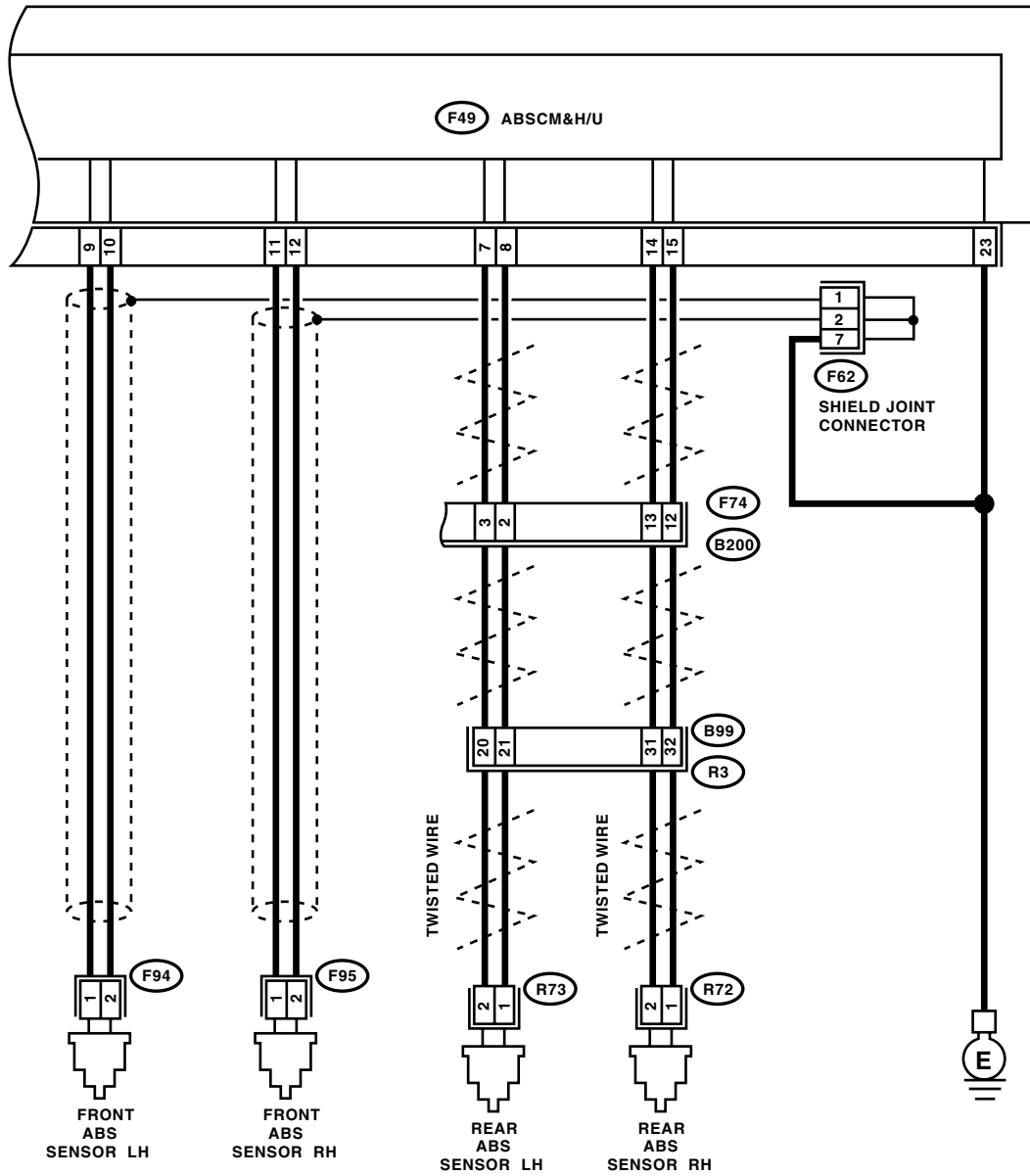

ABS00354

# Diagnostics Procedure with Diagnostic Trouble Code (DTC)

## ABS (DIAGNOSTICS)

Step	Check	Yes	No	
1	<b>CHECK OUTPUT OF ABS WHEEL SPEED SENSOR USING SUBARU SELECT MONITOR.</b> 1) Select "Current data display & Save" on the Subaru Select Monitor. 2) Read the ABS wheel speed sensor output corresponding to faulty system in the Subaru Select Monitor data display mode.	Does the speed indicated on display change in response to speedometer reading during acceleration/deceleration when the steering wheel is in straight-ahead position?	Go to step 2.	Go to step 8.
2	<b>CHECK POOR CONTACT IN CONNECTORS.</b> Turn the ignition switch to OFF.	Is there poor contact in connectors between ABSCM&H/U and ABS wheel speed sensor?	Repair the connector.	Go to step 3.
3	<b>CHECK SOURCES OF SIGNAL NOISE.</b>	Is the car telephone or wireless transmitter properly installed?	Go to step 4.	Properly install the car telephone or wireless transmitter.
4	<b>CHECK SOURCES OF SIGNAL NOISE.</b>	Are noise sources (such as an antenna) installed near the sensor harness?	Install the noise sources apart from sensor harness.	Go to step 5.
5	<b>CHECK SHIELD CIRCUIT.</b> 1) Turn the ignition switch to OFF. 2) Connect all connectors. 3) Measure the resistance between shield connector and chassis ground. <b>Connector &amp; terminal</b> <b>DTC 22</b> <i>LHD: (B303) No. 2 — Chassis ground:</i> <i>RHD: (F62) No. 2 — Chassis ground:</i> <b>DTC 24</b> <i>LHD: (B303) No. 1 — Chassis ground:</i> <i>RHD: (F62) No. 1 — Chassis ground:</i>  NOTE: If the DTC is 26, 28: Go to YES.	Is the resistance less than 0.5 Ω?	Go to step 6.	Repair the shield harness.
6	<b>CHECK ABSCM&amp;H/U.</b> 1) Connect all connectors. 2) Erase the memory. 3) Perform the inspection mode. 4) Read out the DTC.	Is the same DTC as in the current diagnosis still being output?	Replace the ABSCM only. <Ref. to ABS-6, ABS Control Module and Hydraulic Control Unit (ABSCM&H/U).>	Go to step 7.
7	<b>CHECK ANY OTHER DTC APPEARANCE.</b>	Are other DTCs being output?	Proceed with the diagnosis corresponding to DTC.	A temporary noise interference.
8	<b>CHECK INSTALLATION OF ABS WHEEL SPEED SENSOR.</b>	Are the ABS wheel speed sensor installation bolts tightened 33 N·m (3.3 kgf·m, 24 ft·lb)?	Go to step 9.	Tighten the ABS wheel speed sensor installation bolts securely.
9	<b>CHECK ABS WHEEL SPEED SENSOR GAP.</b> Measure the tone wheel to ABS wheel speed sensor piece gap over entire perimeter of wheel.	Is the gap as following value? Front wheel: 0.3 — 0.8 mm (0.012 — 0.031 in) Rear wheel: 0.7 — 1.2 mm (0.028 — 0.047 in)	Go to step 10.	Adjust the gap.  NOTE: Adjust the gap using spacer (Part No. 26755AA000). If the spacers cannot correct gap, replace worn sensor or worn tone wheel.
10	<b>PREPARE OSCILLOSCOPE.</b>	Is an oscilloscope available?	Go to step 11.	Go to step 12.

# Diagnostics Procedure with Diagnostic Trouble Code (DTC)

ABS (DIAGNOSTICS)

Step	Check	Yes	No
<b>11 CHECK ABS WHEEL SPEED SENSOR SIGNAL.</b> 1) Raise all four wheels off ground. 2) Turn the ignition switch to OFF. 3) Connect the oscilloscope to the connector. 4) Turn the ignition switch to ON. 5) Rotate the wheels and measure voltage at specified frequency. <Ref. to ABS(diag)-15, WAVEFORM, Control Module I/O Signal.>  NOTE: When this inspection is completed, the ABSCM&H/U sometimes stores DTC 29 or DTC 56.  <i><b>Connector &amp; terminal</b></i> <b>DTC 22</b> <i>LHD: (B15) No. 1 (+) — No. 2 (-):</i> <i>RHD: (F95) No. 1 (+) — No. 2 (-):</i> <b>DTC 24</b> <i>LHD: (B62) No. 20 (+) — No. 24 (-):</i> <i>RHD: (F94) No. 1 (+) — No. 2 (-):</i> <b>DTC 26</b> <i>LHD: (B99) No. 10 (+) — No. 9 (-):</i> <i>RHD: (B99) No. 32 (+) — No. 31 (-):</i> <b>DTC 28</b> <i>LHD: (B99) No. 5 (+) — No. 4 (-):</i> <i>RHD: (B99) No. 21 (+) — No. 20 (-):</i>	Is an oscilloscope pattern smooth, as shown in the figure?	Go to step 15.	Go to step 12.
<b>12 CHECK CONTAMINATION OF ABS WHEEL SPEED SENSOR OR TONE WHEEL.</b> Remove the disc rotor or drum from hub in accordance with DTC.	Is the ABS wheel speed sensor piece or tone wheel contaminated by dirt or other foreign matter?	Thoroughly remove dirt or other foreign matter.	Go to step 13.
<b>13 CHECK DAMAGE OF ABS WHEEL SPEED SENSOR OR TONE WHEEL.</b>	Are there broken or damaged in the ABS wheel speed sensor piece or tone wheel?	Go to step 14.	Replace the ABS wheel speed sensor or tone wheel. Front: <Ref. to ABS-13, Front ABS Wheel Speed Sensor.> Rear: <Ref. to ABS-16, Rear ABS Wheel Speed Sensor.> and Front: <Ref. to ABS-19, Front Tone Wheel.> Rear: <Ref. to ABS-20, Rear Tone Wheel.>
<b>14 CHECK TONE WHEEL RUNOUT.</b> Measure the tone wheel runout.	Is the runout less than 0.05 mm (0.0020 in)?	Go to step 15.	Replace the tone wheel. Front: <Ref. to ABS-19, Front Tone Wheel.> Rear: <Ref. to ABS-20, Rear Tone Wheel.>



## Diagnostics Procedure with Diagnostic Trouble Code (DTC)

### ABS (DIAGNOSTICS)

Step	Check	Yes	No
<p><b>15 CHECK RESISTANCE OF ABS WHEEL SPEED SENSOR.</b>                      1) Turn the ignition switch to OFF.                      2) Disconnect the connector from ABS wheel speed sensor.                      3) Measure the resistance between ABS wheel speed sensor connector terminals while shaking the harness lightly.</p> <p><b>Terminals</b>  <i>Front RH No. 1 — No. 2:</i>  <i>Front LH No. 1 — No. 2:</i>  <i>Rear RH No. 1 — No. 2:</i>  <i>Rear LH No. 1 — No. 2:</i></p>	<p>Is the resistance as following value?                      Front: 1 — 1.5 kΩ                      Rear: 1.025 — 1.265 kΩ</p>	Go to step 16.	<p>Replace the ABS wheel speed sensor. Front: &lt;Ref. to ABS-13, Front ABS Wheel Speed Sensor.&gt; Rear: &lt;Ref. to ABS-16, Rear ABS Wheel Speed Sensor.&gt;</p>
<p><b>16 CHECK GROUND SHORT OF ABS WHEEL SPEED SENSOR.</b>                      Measure the resistance between ABS wheel speed sensor and chassis ground.</p> <p><b>Terminals</b>  <i>Front RH No. 1 — Chassis ground:</i>  <i>Front LH No. 1 — Chassis ground:</i>  <i>Rear RH No. 1 — Chassis ground:</i>  <i>Rear LH No. 1 — Chassis ground:</i></p>	<p>Is the resistance more than 1 MΩ?</p>	Go to step 17.	<p>Replace the ABS wheel speed sensor. Front: &lt;Ref. to ABS-13, Front ABS Wheel Speed Sensor.&gt; Rear: &lt;Ref. to ABS-16, Rear ABS Wheel Speed Sensor.&gt;</p>
<p><b>17 CHECK HARNESS/CONNECTOR BETWEEN ABSCM&amp;H/U AND ABS WHEEL SPEED SENSOR.</b>                      1) Connect the connector to ABS wheel speed sensor.                      2) Disconnect the connector from ABSCM&amp;H/U.                      3) Measure the resistance at ABSCM&amp;H/U connector terminals.</p> <p><b>Connector &amp; terminal</b>  <b>DTC 22</b>  <i>LHD: (B301) No. 11 — No. 12:</i>  <i>RHD: (F49) No. 11 — No. 12:</i>  <b>DTC 24</b>  <i>LHD: (B301) No. 9 — No. 10:</i>  <i>RHD: (F49) No. 9 — No. 10:</i>  <b>DTC 26</b>  <i>LHD: (B301) No. 14 — No. 15:</i>  <i>RHD: (F49) No. 14 — No. 15:</i>  <b>DTC 28</b>  <i>LHD: (B301) No. 7 — No. 8:</i>  <i>RHD: (F49) No. 7 — No. 8:</i></p>	<p>Is the resistance as following value?                      Front: 1 — 1.5 kΩ                      Rear: 1.025 — 1.265 kΩ</p>	Go to step 18.	<p>Repair the harness/connector between ABSCM&amp;H/U and ABS wheel speed sensor.</p>
<p><b>18 CHECK GROUND SHORT OF HARNESS.</b>                      Measure the resistance between ABSCM&amp;H/U connector and chassis ground.</p> <p><b>Connector &amp; terminal</b>  <b>DTC 22</b>  <i>LHD: (B301) No. 11 — Chassis ground:</i>  <i>RHD: (F49) No. 11 — Chassis ground:</i>  <b>DTC 24</b>  <i>LHD: (B301) No. 9 — Chassis ground:</i>  <i>RHD: (F49) No. 9 — Chassis ground:</i>  <b>DTC 26</b>  <i>LHD: (B301) No. 14 — Chassis ground:</i>  <i>RHD: (F49) No. 14 — Chassis ground:</i>  <b>DTC 28</b>  <i>LHD: (B301) No. 7 — Chassis ground:</i>  <i>RHD: (F49) No. 7 — Chassis ground:</i></p>	<p>Is the resistance more than 1 MΩ?</p>	Go to step 19.	<p>Repair the harness/connector between ABSCM&amp;H/U and ABS wheel speed sensor.</p>

# Diagnostics Procedure with Diagnostic Trouble Code (DTC)

ABS (DIAGNOSTICS)

Step	Check	Yes	No
<b>19 CHECK GROUND CIRCUIT OF ABSCM&amp;H/U.</b> Measure the resistance between ABSCM&H/U and chassis ground. <i>Connector &amp; terminal</i> <i>LHD: (B301) No. 23 — Chassis ground:</i> <i>RHD: (F49) No. 23 — Chassis ground:</i>	Is the resistance less than 0.5 $\Omega$ ?	Go to step 20.	Repair the ABSCM&H/U ground harness.
<b>20 CHECK POOR CONTACT IN CONNECTORS.</b>	Is there poor contact in connectors between ABSCM&H/U and ABS wheel speed sensor?	Repair the connector.	Go to step 21.
<b>21 CHECK SOURCES OF SIGNAL NOISE.</b>	Is the car telephone or the wireless transmitter properly installed?	Go to step 22.	Properly install the car telephone or wireless transmitter.
<b>22 CHECK SOURCES OF SIGNAL NOISE.</b>	Are noise sources (such as an antenna) installed near the sensor harness?	Install the noise sources apart from sensor harness.	Go to step 23.
<b>23 CHECK SHIELD CIRCUIT.</b> 1)Connect all connectors. 2)Measure the resistance between shield connector and chassis ground. <i>Connector &amp; terminal</i> <b>DTC 22</b> <i>LHD: (B303) No. 2 — Chassis ground:</i> <i>RHD: (F62) No. 2 — Chassis ground:</i> <b>DTC 24</b> <i>LHD: (B303) No. 1 — Chassis ground:</i> <i>RHD: (F62) No. 1 — Chassis ground:</i>  NOTE: If the DTC is 26, 28: Go to YES.	Is the resistance less than 0.5 $\Omega$ ?	Go to step 24.	Repair the shield harness.
<b>24 CHECK ABSCM&amp;H/U.</b> 1)Connect all connectors. 2)Erase the memory. 3)Perform the inspection mode. 4)Read out the DTC.	Is the same DTC as in the current diagnosis still being output?	Replace the ABSCM only. <Ref. to ABS-6, ABS Control Module and Hydraulic Control Unit (ABSCM&H/U).>	Go to step 25.
<b>25 CHECK ANY OTHER DTC APPEARANCE.</b>	Are other DTCs being output?	Proceed with the diagnosis corresponding to DTC.	A temporary noise interference.  NOTE: Although the ABS warning light remains illuminating at this point, this is a normal condition. Vehicle must be driven at approx. 12 km/h (7.46 MPH) or faster to turn off ABS warning light. Make sure that the ABS warning light goes off after driving vehicle.

## **Diagnostics Procedure with Diagnostic Trouble Code (DTC)**

ABS (DIAGNOSTICS)

---

### **K: DTC 29 ABNORMAL ABS WHEEL SPEED SENSOR SIGNAL ON ANY ONE OF FOUR SENSOR**

#### **DIAGNOSIS:**

- Faulty ABS wheel speed sensor signal (noise, irregular signal, etc.)
- Faulty tone wheel
- Wheels turning freely for a long time

#### **TROUBLE SYMPTOM:**

- ABS does not operate.
- EBD does not operate.

#### **NOTE:**

In addition to the ABS warning light, brake warning light illuminates.

# Diagnostics Procedure with Diagnostic Trouble Code (DTC)

ABS (DIAGNOSTICS)

## WIRING DIAGRAM: LHD MODEL

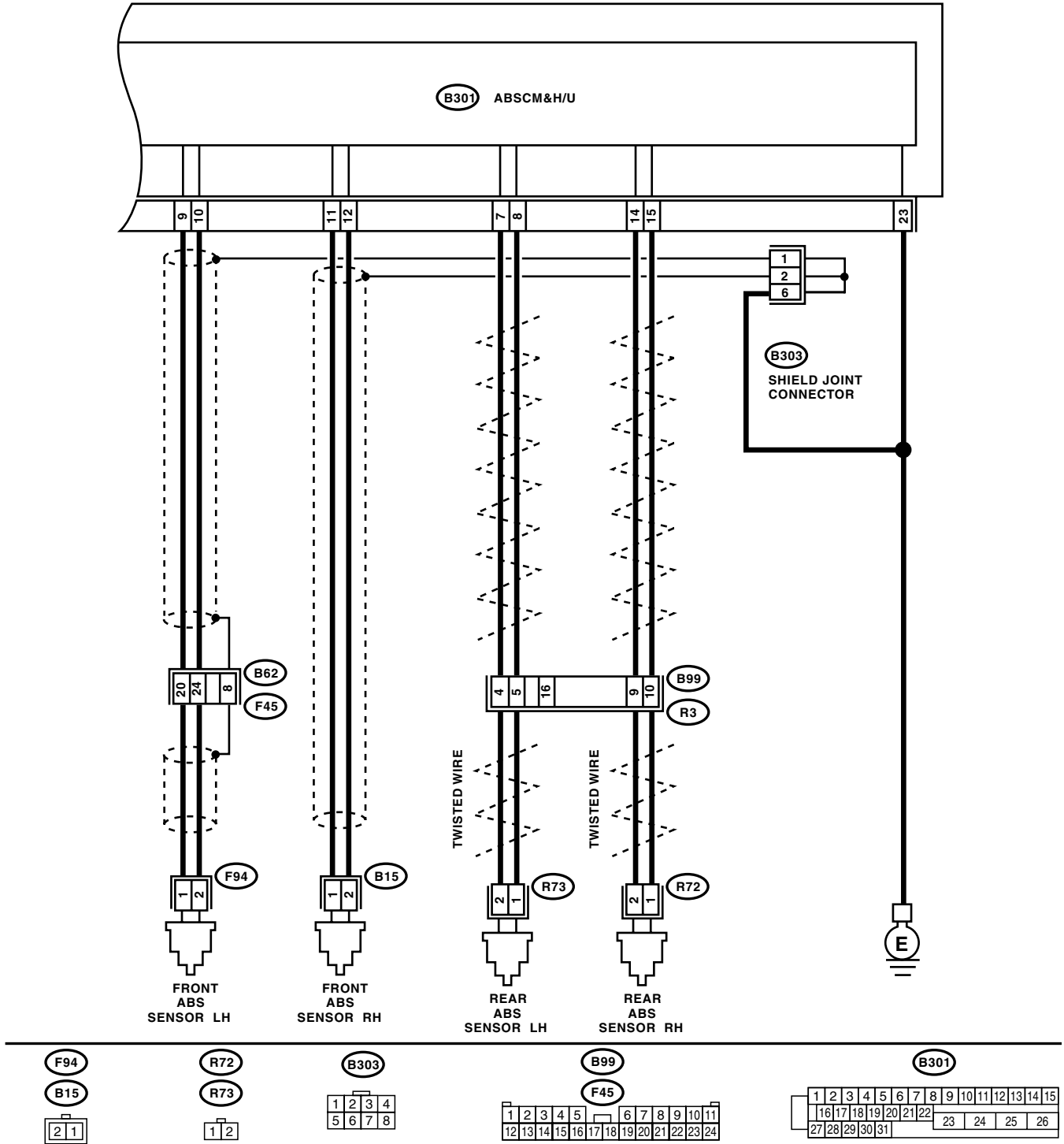

ABS00353

# Diagnostics Procedure with Diagnostic Trouble Code (DTC)

ABS (DIAGNOSTICS)

RHD MODEL

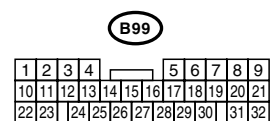
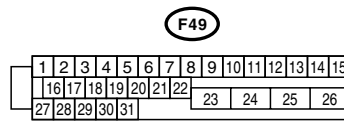
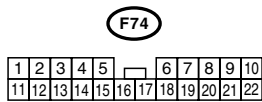
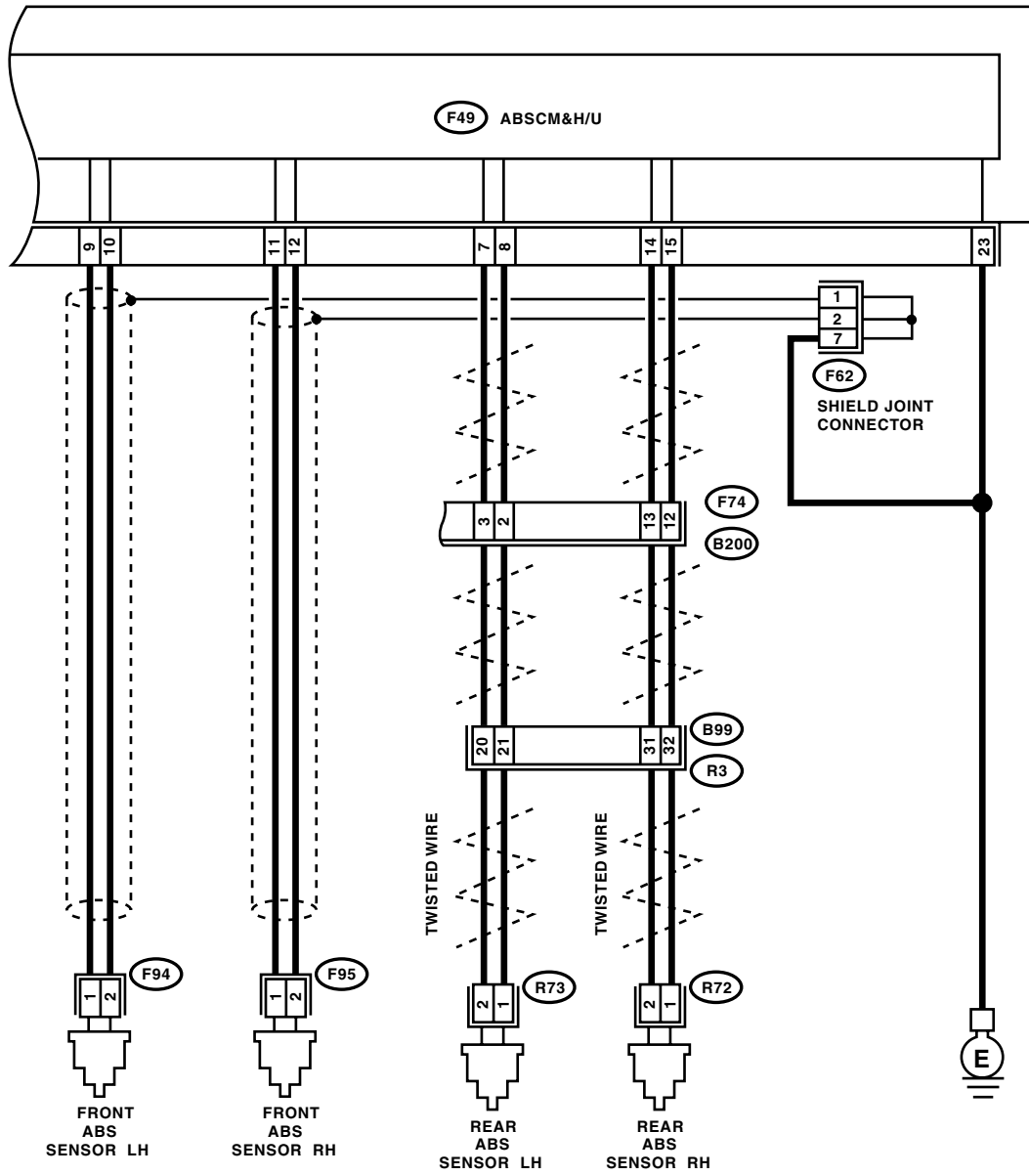

ABS00354

# Diagnostics Procedure with Diagnostic Trouble Code (DTC)

ABS (DIAGNOSTICS)

Step	Check	Yes	No	
1	<b>CHECK IF THE WHEELS HAVE TURNED FREELY FOR A LONG TIME.</b>	Is the wheels have been turned freely for more than one minute, such as when vehicle is jacked-up, under full-lock cornering or the tires not in contact with road surface?	The ABS is normal. Erase the DTC. <b>NOTE:</b> When the wheels turn freely for a long time, such as when vehicle is towed or jacked-up, or when steering wheel is continuously turned all way, this DTC may sometimes occur.	Go to step 2.
2	<b>CHECK TIRE SPECIFICATIONS.</b> Turn the ignition switch to OFF.	Are the tire specifications correct?	Go to step 3.	Replace the tire.
3	<b>CHECK WEAR OF TIRE.</b>	Is the tire worn excessively?	Replace the tire.	Go to step 4.
4	<b>CHECK TIRE PRESSURE.</b>	Is the tire pressure correct?	Go to step 5.	Adjust the tire pressure.
5	<b>CHECK INSTALLATION OF ABS WHEEL SPEED SENSOR.</b>	Are the ABS wheel speed sensor installation bolts tightened 33 N·m (3.3 kgf-m, 24 ft-lb)?	Go to step 6.	Tighten the ABS wheel speed sensor installation bolts securely.
6	<b>CHECK ABS WHEEL SPEED SENSOR GAP.</b> Measure the tone wheel to ABS wheel speed sensor piece gap over entire perimeter of the wheel.	Is the gap as following value? Front wheel: 0.3 — 0.8 mm (0.012 — 0.031 in) Rear wheel: 0.7 — 1.2 mm (0.028 — 0.047 in)	Go to step 7.	Adjust the gap. <b>NOTE:</b> Adjust the gap using spacer (Part No. 26755AA000). If the spacers cannot correct gap, replace worn sensor or worn tone wheel.
7	<b>PREPARE OSCILLOSCOPE.</b>	Is an oscilloscope available?	Go to step 8.	Go to step 9.
8	<b>CHECK ABS WHEEL SPEED SENSOR SIGNAL.</b> 1) Raise all four wheels off ground. 2) Turn the ignition switch to OFF. 3) Connect the oscilloscope to the connector. 4) Turn the ignition switch to ON. 5) Rotate the wheels and measure voltage at specified frequency. <Ref. to ABS(diag)-15, WAVEFORM, Control Module I/O Signal.> <b>NOTE:</b> When this inspection is completed, ABSCM&H/U sometimes stores the DTC 29. <b>Connector &amp; terminal</b> <b>Front RH</b> LHD: (B15) No. 1 (+) — No. 2 (-): RHD: (F95) No. 1 (+) — No. 2 (-): <b>Front LH</b> LHD: (B62) No. 20 (+) — No. 24 (-): RHD: (F94) No. 1 (+) — No. 2 (-): <b>Rear RH</b> LHD: (B99) No. 10 (+) — No. 9 (-): RHD: (B99) No. 32 (+) — No. 31 (-): <b>Rear LH</b> LHD: (B99) No. 5 (+) — No. 4 (-): RHD: (B99) No. 21 (+) — No. 22 (-):	Is an oscilloscope pattern smooth, as shown in the figure?	Go to step 12.	Go to step 9.

## Diagnostics Procedure with Diagnostic Trouble Code (DTC)

ABS (DIAGNOSTICS)

Step	Check	Yes	No	
<b>9</b>	<b>CHECK CONTAMINATION OF ABS WHEEL SPEED SENSOR OR TONE WHEEL.</b> Remove the disc rotor or drum from hub.	Is the ABS wheel speed sensor piece or tone wheel contaminated by dirt or other foreign matter?	Thoroughly remove dirt or other foreign matter.	Go to step 10.
<b>10</b>	<b>CHECK DAMAGE OF ABS WHEEL SPEED SENSOR OR TONE WHEEL.</b>	Are there broken or damaged teeth in the ABS wheel speed sensor piece or tone wheel?	Replace the ABS wheel speed sensor or tone wheel. Front: <Ref. to ABS-13, Front ABS Wheel Speed Sensor.> Rear: <Ref. to ABS-16, Rear ABS Wheel Speed Sensor.> and Front: <Ref. to ABS-19, Front Tone Wheel.> Rear: <Ref. to ABS-20, Rear Tone Wheel.>	Go to step 11.
<b>11</b>	<b>CHECK TONE WHEEL RUNOUT.</b> Measure the tone wheel runout.	Is the runout less than 0.05 mm (0.0020 in)?	Go to step 12.	Replace the tone wheel. Front: <Ref. to ABS-19, Front Tone Wheel.> Rear: <Ref. to ABS-20, Rear Tone Wheel.>
<b>12</b>	<b>CHECK ABSCM&amp;H/U.</b> 1)Turn the ignition switch to OFF. 2)Connect all connectors. 3)Erase the memory. 4)Perform the inspection mode. 5)Read out the DTC.	Is the same DTC as in the current diagnosis still being output?	Replace the ABSCM only. <Ref. to ABS-6, ABS Control Module and Hydraulic Control Unit (ABSCM&H/U).>	Go to step 13.
<b>13</b>	<b>CHECK ANY OTHER DTC APPEARANCE.</b>	Are other DTCs being output?	Proceed with the diagnosis corresponding to DTC.	A temporary poor contact.

### L: DTC 31 FRONT RIGHT INLET VALVE MALFUNCTION

NOTE:

For the diagnostic procedure, refer to DTC 37. <Ref. to ABS(diag)-63, DTC 37 REAR LEFT INLET VALVE MALFUNCTION, Diagnostics Procedure with Diagnostic Trouble Code (DTC).>

### M: DTC 33 FRONT LEFT INLET VALVE MALFUNCTION

NOTE:

For the diagnostic procedure, refer to DTC 37. <Ref. to ABS(diag)-63, DTC 37 REAR LEFT INLET VALVE MALFUNCTION, Diagnostics Procedure with Diagnostic Trouble Code (DTC).>

### N: DTC 35 REAR RIGHT INLET VALVE MALFUNCTION

NOTE:

For the diagnostic procedure, refer to DTC 37. <Ref. to ABS(diag)-63, DTC 37 REAR LEFT INLET VALVE MALFUNCTION, Diagnostics Procedure with Diagnostic Trouble Code (DTC).>

## **O: DTC 37 REAR LEFT INLET VALVE MALFUNCTION**

### **DIAGNOSIS:**

- Faulty harness/connector
- Faulty inlet solenoid valve

### **TROUBLE SYMPTOM:**

- ABS does not operate.
- EBD does not operate.

### **NOTE:**

In addition to the ABS warning light, brake warning light illuminates.



# Diagnostics Procedure with Diagnostic Trouble Code (DTC)

ABS (DIAGNOSTICS)

## WIRING DIAGRAM:

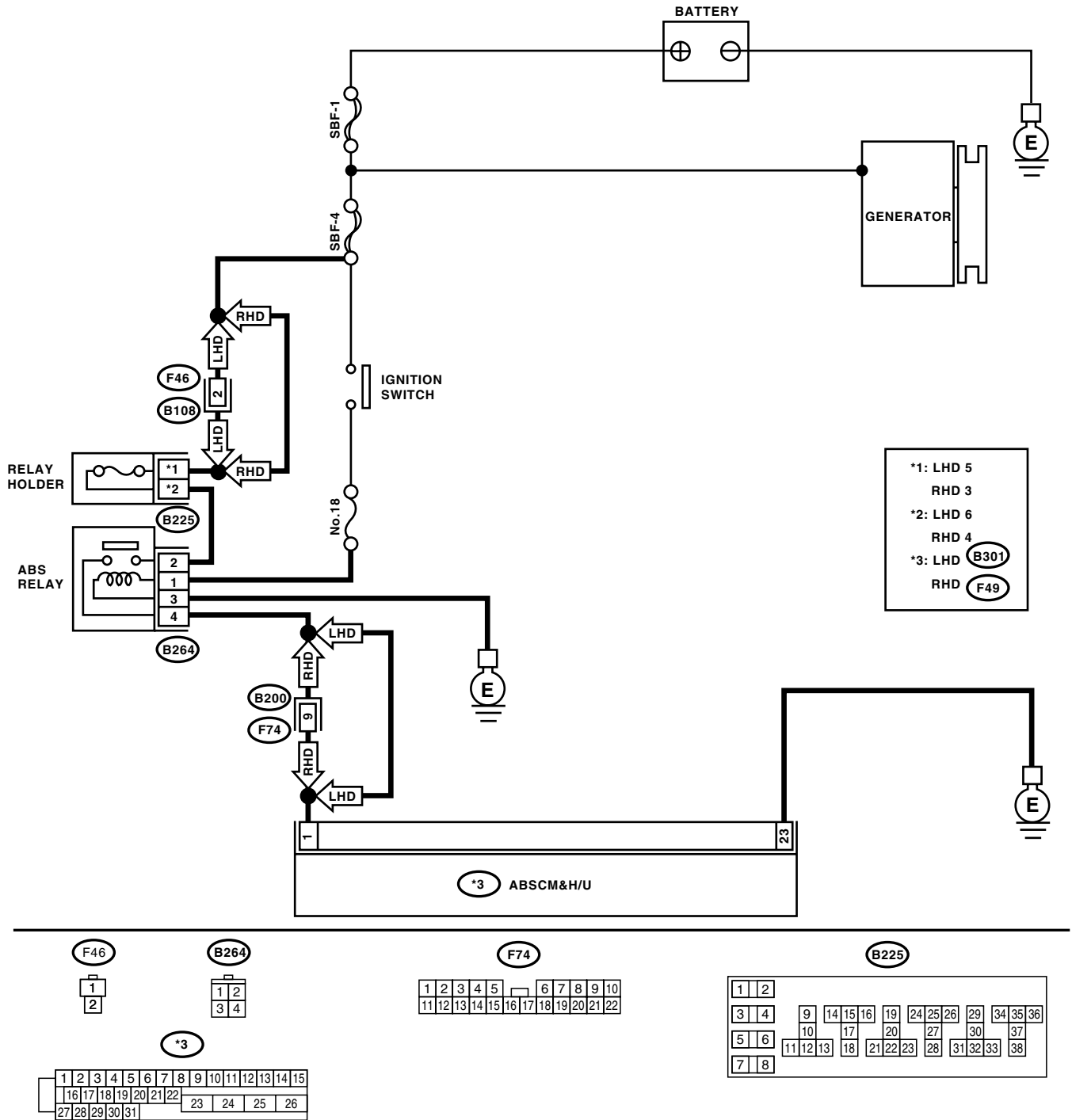

ABS00356

# Diagnostics Procedure with Diagnostic Trouble Code (DTC)

ABS (DIAGNOSTICS)

Step	Check	Yes	No
<b>1 CHECK INPUT VOLTAGE OF ABSCM&amp;H/U.</b> 1) Turn the ignition switch to OFF. 2) Disconnect the connector from ABSCM&H/U. 3) Run the engine at idle. 4) Measure the voltage between ABSCM&H/U connector and chassis ground. <i><b>Connector &amp; terminal</b></i> <i><b>LHD: (B301) No. 1 (+) — Chassis ground (-):</b></i> <i><b>RHD: (F49) No. 1 (+) — Chassis ground (-):</b></i>	Is the voltage 10 — 15 V?	Go to step 2.	Repair the harness connector between battery, ignition switch and ABSCM&H/U.
<b>2 CHECK GROUND CIRCUIT OF ABSCM&amp;H/U.</b> 1) Turn the ignition switch to OFF. 2) Measure the resistance between ABSCM&H/U connector and chassis ground. <i><b>Connector &amp; terminal</b></i> <i><b>LHD: (B301) No. 23 — Chassis ground:</b></i> <i><b>RHD: (F49) No. 23 — Chassis ground:</b></i>	Is the resistance less than 0.5 Ω?	Go to step 3.	Repair the ABSCM&H/U ground harness.
<b>3 CHECK POOR CONTACT IN CONNECTORS.</b>	Is there poor contact in connectors between generator, battery and ABSCM&H/U?	Repair the connector.	Go to step 4.
<b>4 CHECK ABSCM&amp;H/U.</b> 1) Connect all connectors. 2) Erase the memory. 3) Perform the inspection mode. 4) Read out the DTC.	Is the same DTC as in the current diagnosis still being output?	Replace the ABSCM&H/U. <Ref. to ABS-6, ABS Control Module and Hydraulic Control Unit (ABSCM&H/U).>	Go to step 5.
<b>5 CHECK ANY OTHER DTC APPEARANCE.</b>	Are other DTCs being output?	Proceed with the diagnosis corresponding to DTC.	A temporary poor contact.

## P: DTC 32 FRONT RIGHT OUTLET VALVE MALFUNCTION

NOTE:

For the diagnostic procedure, refer to DTC 38. <Ref. to ABS(diag)-66, DTC 38 REAR LEFT OUTLET VALVE MALFUNCTION, Diagnostics Procedure with Diagnostic Trouble Code (DTC).>

## Q: DTC 34 FRONT LEFT OUTLET VALVE MALFUNCTION

NOTE:

For the diagnostic procedure, refer to DTC 38. <Ref. to ABS(diag)-66, DTC 38 REAR LEFT OUTLET VALVE MALFUNCTION, Diagnostics Procedure with Diagnostic Trouble Code (DTC).>

## R: DTC 36 REAR RIGHT OUTLET VALVE MALFUNCTION

NOTE:

For the diagnostic procedure, refer to DTC 38. <Ref. to ABS(diag)-66, DTC 38 REAR LEFT OUTLET VALVE MALFUNCTION, Diagnostics Procedure with Diagnostic Trouble Code (DTC).>

## **Diagnostics Procedure with Diagnostic Trouble Code (DTC)**

ABS (DIAGNOSTICS)

---

### **S: DTC 38 REAR LEFT OUTLET VALVE MALFUNCTION**

#### **DIAGNOSIS:**

- Faulty harness/connector
- Faulty outlet solenoid valve

#### **TROUBLE SYMPTOM:**

- ABS does not operate.
- EBD does not operate.

#### **NOTE:**

In addition to the ABS warning light, brake warning light illuminates.

# Diagnostics Procedure with Diagnostic Trouble Code (DTC)

ABS (DIAGNOSTICS)

## WIRING DIAGRAM:

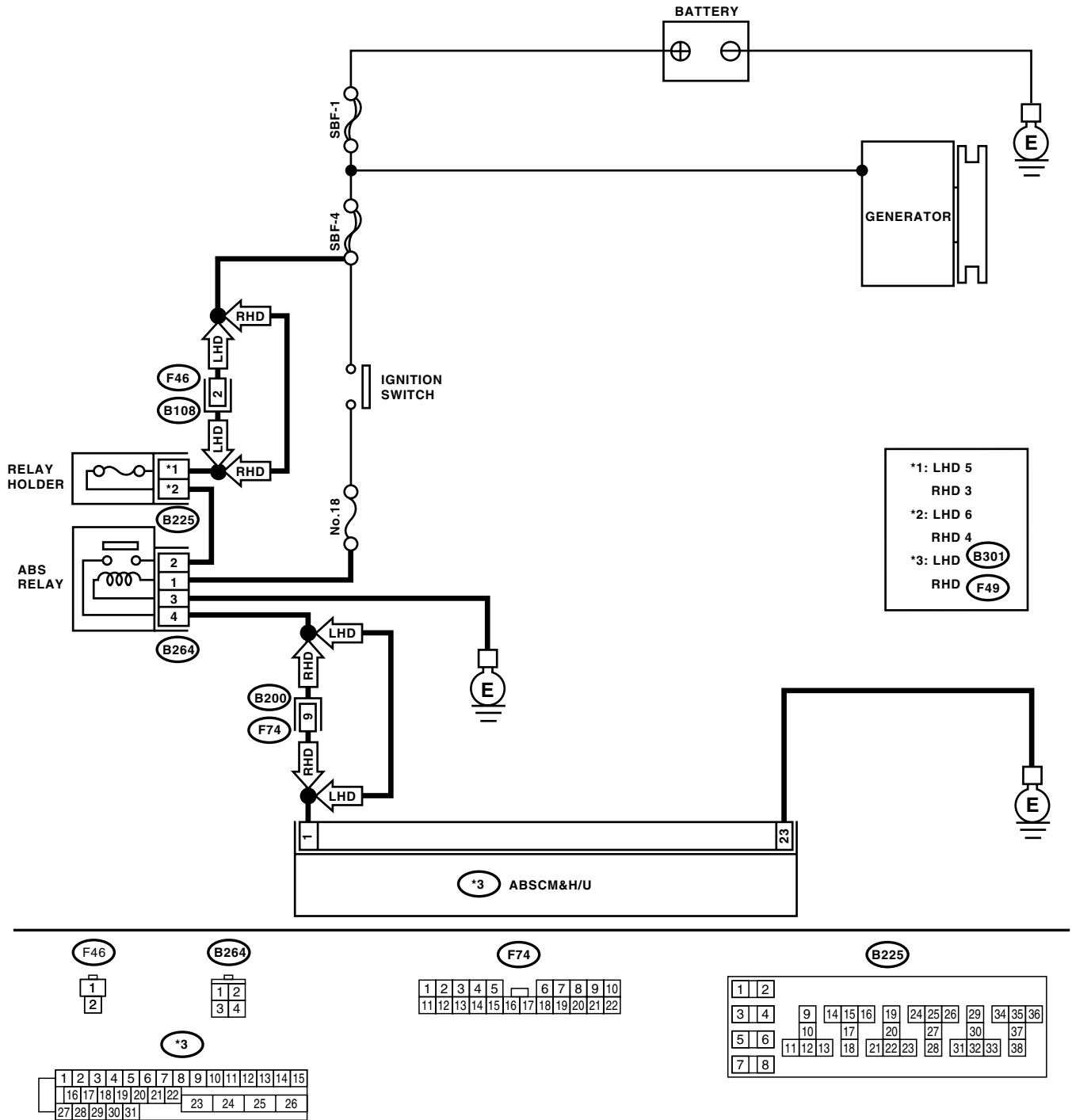

ABS00356

## Diagnostics Procedure with Diagnostic Trouble Code (DTC)

### ABS (DIAGNOSTICS)

Step	Check	Yes	No
<b>1 CHECK INPUT VOLTAGE OF ABSCM&amp;H/U.</b> 1) Turn the ignition switch to OFF. 2) Disconnect the connector from ABSCM&H/U. 3) Run the engine at idle. 4) Measure the voltage between ABSCM&H/U connector and chassis ground. <i><b>Connector &amp; terminal</b></i> <i><b>LHD: (B301) No. 1 (+) — Chassis ground (-):</b></i> <i><b>RHD: (F49) No. 1 (+) — Chassis ground (-):</b></i>	Is the voltage 10 — 15 V?	Go to step 2.	Repair the harness connector between battery, ignition switch and ABSCM&H/U.
<b>2 CHECK GROUND CIRCUIT OF ABSCM&amp;H/U.</b> 1) Turn the ignition switch to OFF. 2) Measure the resistance between ABSCM&H/U connector and chassis ground. <i><b>Connector &amp; terminal</b></i> <i><b>LHD: (B301) No. 23 — Chassis ground:</b></i> <i><b>RHD: (F49) No. 23 — Chassis ground:</b></i>	Is the resistance less than 0.5 $\Omega$ ?	Go to step 3.	Repair the ABSCM&H/U ground harness.
<b>3 CHECK POOR CONTACT IN CONNECTORS.</b>	Is there poor contact in connectors between generator, battery and ABSCM&H/U?	Repair the connector.	Go to step 4.
<b>4 CHECK ABSCM&amp;H/U.</b> 1) Connect all connectors. 2) Erase the memory. 3) Perform the inspection mode. 4) Read out the DTC.	Is the same DTC as in the current diagnosis still being output?	Replace the ABSCM&H/U. <Ref. to ABS-6, ABS Control Module and Hydraulic Control Unit (ABSCM&H/U).>	Go to step 5.
<b>5 CHECK ANY OTHER DTC APPEARANCE.</b>	Are other DTCs being output?	Proceed with the diagnosis corresponding to DTC.	A temporary poor contact.

## T: DTC 41 ABS CONTROL MODULE MALFUNCTION

### DIAGNOSIS:

- Faulty ABSCM&H/U

### TROUBLE SYMPTOM:

- ABS does not operate.
- EBD does not operate.

### NOTE:

In addition to the ABS warning light, brake warning light illuminates.

### WIRING DIAGRAM:

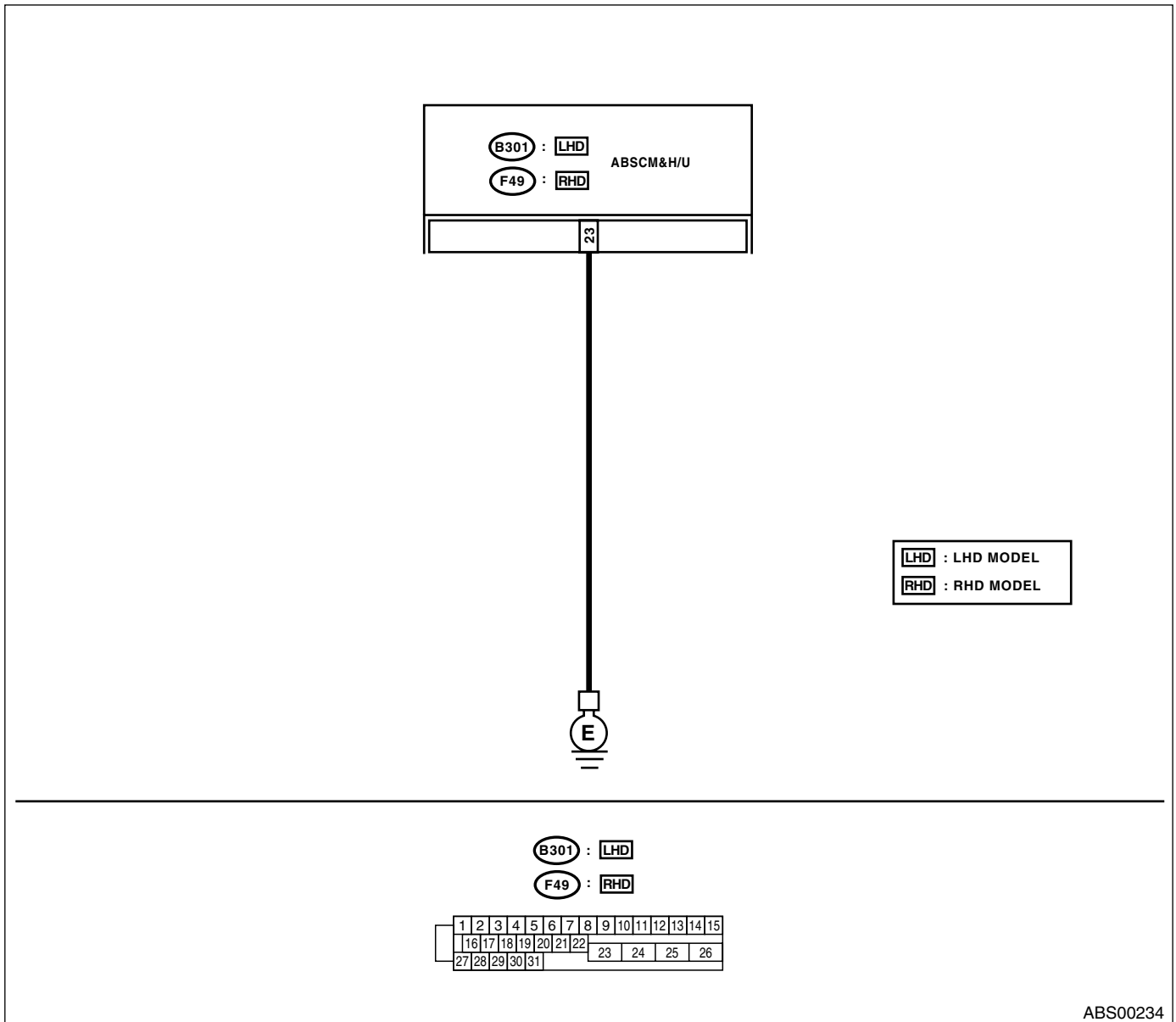

## Diagnostics Procedure with Diagnostic Trouble Code (DTC)

ABS (DIAGNOSTICS)

Step	Check	Yes	No
<b>1 CHECK GROUND CIRCUIT OF ABSCM&amp;H/U.</b> 1)Turn the ignition switch to OFF. 2)Disconnect the connector from ABSCM&H/U. 3)Measure the resistance between ABSCM&H/U and chassis ground. <i>Connector &amp; terminal</i> <i>LHD: (B301) No. 23 — Chassis ground:</i> <i>RHD: (F49) No. 23 — Chassis ground:</i>	Is the resistance less than 0.5 $\Omega$ ?	Go to step 2.	Repair the ABSCM&H/U ground harness.
<b>2 CHECK POOR CONTACT IN CONNECTORS.</b>	Is there poor contact in connectors between battery, ignition switch and ABSCM&H/U?	Repair the connector.	Go to step 3.
<b>3 CHECK SOURCES OF SIGNAL NOISE.</b>	Is the car telephone or wireless transmitter properly installed?	Go to step 4.	Properly install the car telephone or wireless transmitter.
<b>4 CHECK SOURCES OF SIGNAL NOISE.</b>	Are noise sources (such as an antenna) installed near the sensor harness?	Install the noise sources apart from sensor harness.	Go to step 5.
<b>5 CHECK ABSCM&amp;H/U.</b> 1)Turn the ignition switch to OFF. 2)Connect all connectors. 3)Erase the memory. 4)Perform the inspection mode. 5)Read out the DTC.	Is the same DTC as in current diagnosis still being output?	Replace the ABSCM only. <Ref. to ABS-6, ABS Control Module and Hydraulic Control Unit (ABSCM&H/U).>	Go to step 6.
<b>6 CHECK ANY OTHER DTC APPEARANCE.</b>	Are other DTCs being output?	Proceed with the diagnosis corresponding to DTC.	A temporary poor contact.

## **U: DTC 42 POWER SUPPLY VOLTAGE TOO LOW**

### **DIAGNOSIS:**

- Power source voltage of the ABSCM&H/U is low.

### **TROUBLE SYMPTOM:**

- ABS does not operate.
- EBD may not operate.

### **NOTE:**

In addition to the ABS warning light, brake warning light illuminates temporarily when the EBD does not operate. Both warning lights go off on the recovery of voltage.



# Diagnostics Procedure with Diagnostic Trouble Code (DTC)

ABS (DIAGNOSTICS)

## WIRING DIAGRAM:

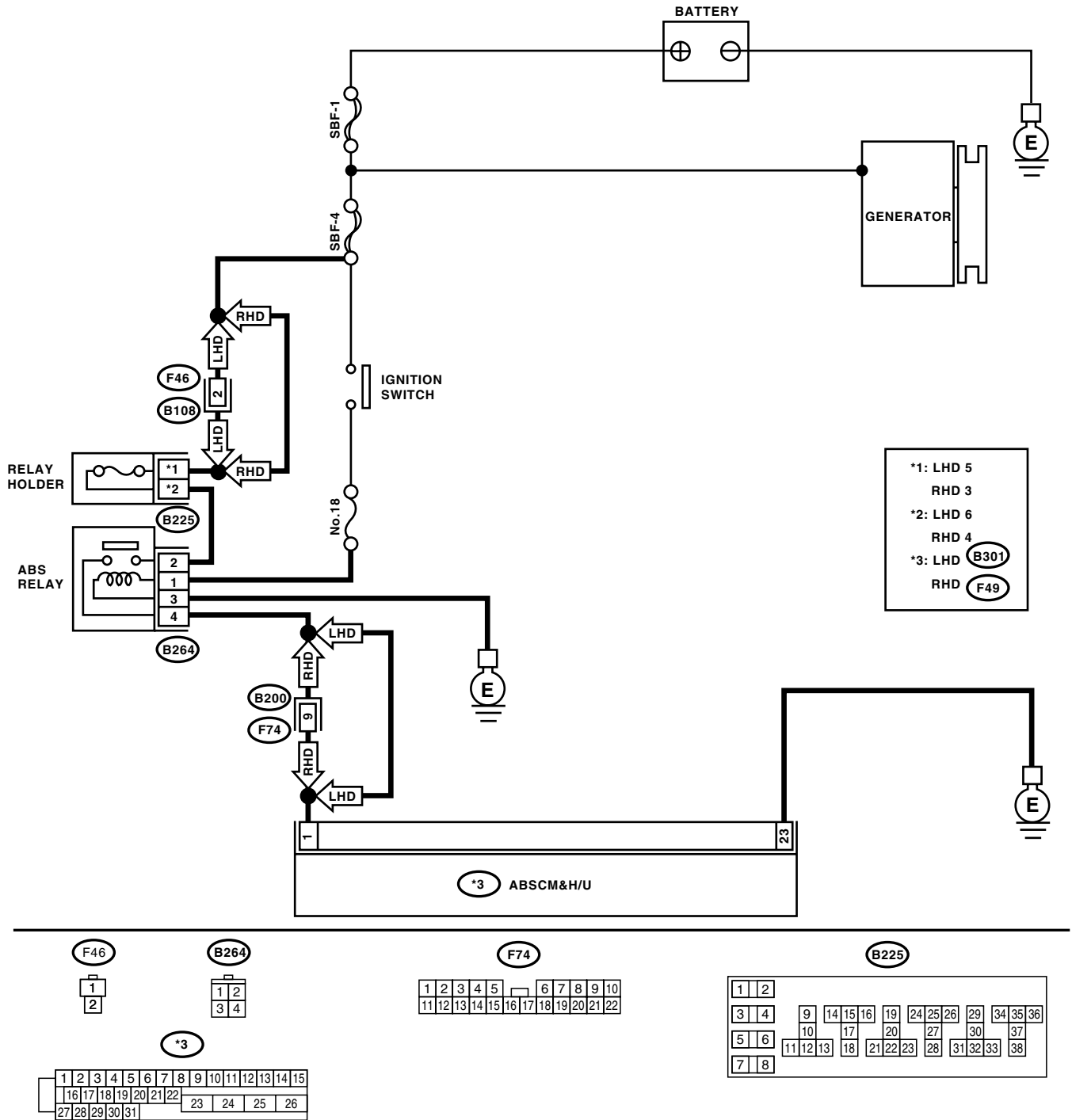

ABS00356

# Diagnostics Procedure with Diagnostic Trouble Code (DTC)

ABS (DIAGNOSTICS)

Step	Check	Yes	No
<b>1 CHECK GENERATOR.</b> 1)Start the engine. 2)Idle after warm-up. 3)Measure the voltage between generator B terminal and chassis ground. <b>Terminals</b> <b>Generator B terminal (+) — Chassis ground (-):</b>	Is the voltage 10 — 17 V?	Go to step 2.	Repair the generator. <Ref. to SC(H4SO)-13, Generator.>
<b>2 CHECK BATTERY TERMINAL.</b> Turn the ignition switch to OFF.	Are the positive and negative battery terminals tightly clamped?	Go to step 3.	Tighten the clamp of terminal.
<b>3 CHECK INPUT VOLTAGE OF ABSCM&amp;H/U.</b> 1)Disconnect the connector from ABSCM&H/U. 2)Run the engine at idle. 3)Operate the electric load applying devices, such as the headlight, A/C, and defogger. 4)Measure the voltage between ABSCM&H/U connector and chassis ground. <b>Connector &amp; terminal</b> <b>LHD: (B301) No. 1 (+) — Chassis ground (-):</b> <b>RHD: (F49) No. 1 (+) — Chassis ground (-):</b>	Is the voltage 10 — 17 V?	Go to step 4.	Repair the harness connector between battery, ignition switch and ABSCM&H/U.
<b>4 CHECK GROUND CIRCUIT OF ABSCM&amp;H/U.</b> 1)Turn the ignition switch to OFF. 2)Measure the resistance between ABSCM&H/U connector and chassis ground. <b>Connector &amp; terminal</b> <b>LHD: (B301) No. 23 — Chassis ground:</b> <b>RHD: (F49) No. 23 — Chassis ground:</b>	Is the resistance less than 0.5 $\Omega$ ?	Go to step 5.	Repair the ABSCM&H/U ground harness.
<b>5 CHECK POOR CONTACT IN CONNECTORS.</b>	Is there poor contact in connectors between generator, battery and ABSCM&H/U?	Repair the connector.	Go to step 6.
<b>6 CHECK ABSCM&amp;H/U.</b> 1)Connect all connectors. 2)Erase the memory. 3)Perform the inspection mode. 4)Read out the DTC.	Is the same DTC as in the current diagnosis still being output?	Replace the ABSCM only. <Ref. to ABS-6, ABS Control Module and Hydraulic Control Unit (ABSCM&H/U).>	Go to step 7.
<b>7 CHECK ANY OTHER DTC APPEARANCE.</b>	Are other DTCs being output?	Proceed with the diagnosis corresponding to DTC.	A temporary poor contact.

## **Diagnostics Procedure with Diagnostic Trouble Code (DTC)**

ABS (DIAGNOSTICS)

---

### **V: DTC 42 POWER SUPPLY VOLTAGE TOO HIGH**

#### **DIAGNOSIS:**

- Power source voltage of the ABSCM&H/U is high.

#### **TROUBLE SYMPTOM:**

- ABS does not operate.
- EBD may not operate.

#### **NOTE:**

In addition to the ABS warning light, brake warning light illuminates temporarily when the EBD does not operate. Both warning lights go off on the recovery of voltage.

# Diagnostics Procedure with Diagnostic Trouble Code (DTC)

ABS (DIAGNOSTICS)

## WIRING DIAGRAM:

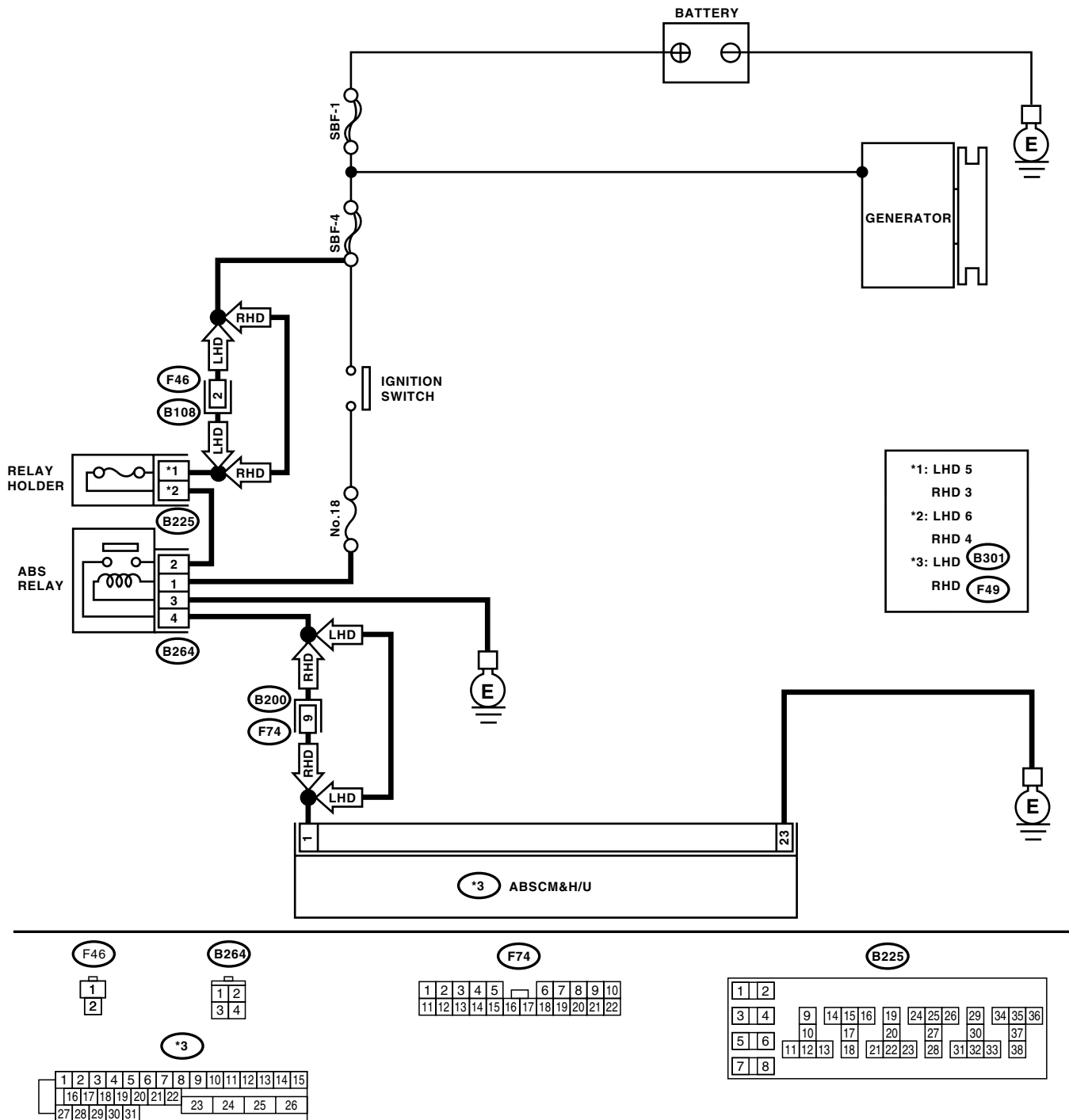

ABS00356

## Diagnostics Procedure with Diagnostic Trouble Code (DTC)

### ABS (DIAGNOSTICS)

Step	Check	Yes	No
<b>1 CHECK GENERATOR.</b> 1)Start the engine. 2)Idle after warm-up. 3)Measure the voltage between generator B terminal and chassis ground. <b>Terminals</b> <b>Generator B terminal (+) — Chassis ground (-):</b>	Is the voltage 10 — 17 V?	Go to step 2.	Repair the generator. <Ref. to SC(H4SO)-13, Generator.>
<b>2 CHECK BATTERY TERMINAL.</b> Turn the ignition switch to OFF.	Are the positive and negative battery terminals tightly clamped?	Go to step 3.	Tighten the clamp of terminal.
<b>3 CHECK INPUT VOLTAGE OF ABSCM&amp;H/U.</b> 1)Disconnect the connector from ABSCM&H/U. 2)Run the engine at idle. 3)Operate the electric load applying devices, such as the headlight, A/C, and defogger. 4)Measure the voltage between ABSCM&H/U connector and chassis ground. <b>Connector &amp; terminal</b> <b>LHD: (B301) No. 1 (+) — Chassis ground (-):</b> <b>RHD: (F49) No. 1 (+) — Chassis ground (-):</b>	Is the voltage 10 and 17 V?	Go to step 4.	Repair the harness connector between battery, ignition switch and ABSCM&H/U.
<b>4 CHECK GROUND CIRCUIT OF ABSCM&amp;H/U.</b> 1)Turn the ignition switch to OFF. 2)Measure the resistance between ABSCM&H/U connector and chassis ground. <b>Connector &amp; terminal</b> <b>LHD: (B301) No. 23 — Chassis ground:</b> <b>RHD: (F49) No. 23 — Chassis ground:</b>	Is the resistance less than 0.5 $\Omega$ ?	Go to step 5.	Repair the ABSCM&H/U ground harness.
<b>5 CHECK POOR CONTACT IN CONNECTORS.</b>	Is there poor contact in connectors between generator, battery and ABSCM&H/U?	Repair the connector.	Go to step 6.
<b>6 CHECK ABSCM&amp;H/U.</b> 1)Connect all connectors. 2)Erase the memory. 3)Perform the inspection mode. 4)Read out the DTC.	Is the same DTC as in the current diagnosis still being output?	Replace the ABSCM only. <Ref. to ABS-6, ABS Control Module and Hydraulic Control Unit (ABSCM&H/U).>	Go to step 7.
<b>7 CHECK ANY OTHER DTC APPEARANCE.</b>	Are other DTCs being output?	Proceed with the diagnosis corresponding to DTC.	A temporary poor contact.

## W: DTC 44 ABS-AT CONTROL (NON CONTROLLED)

### DIAGNOSIS:

- Combination of AT control faults

### TROUBLE SYMPTOM:

- ABS does not operate.

### WIRING DIAGRAM:

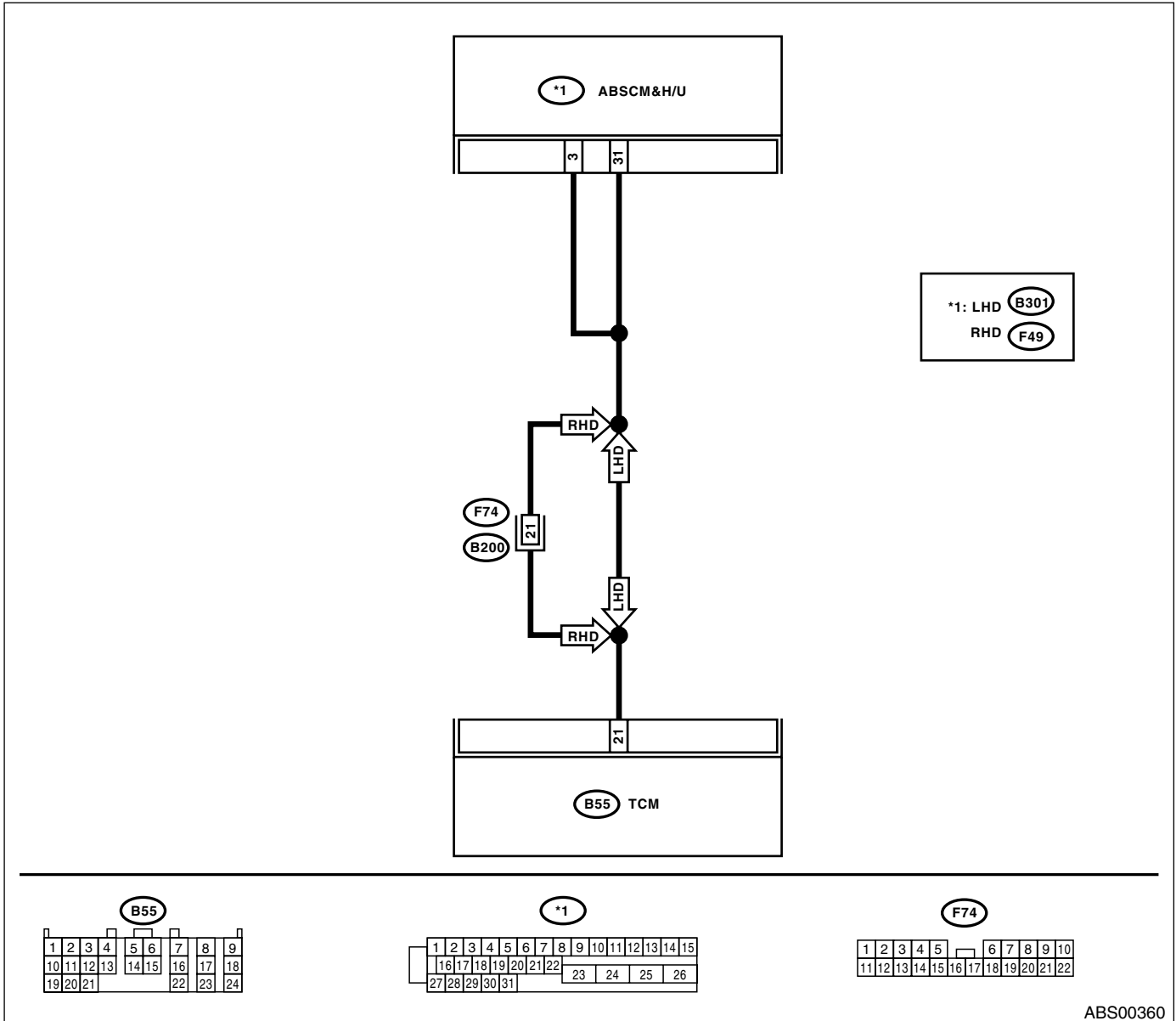

Step	Check	Yes	No	
1	<p><b>CHECK SPECIFICATIONS OF THE AB-SCM&amp;H/U.</b>                      Check specifications of mark on ABSCM&amp;H/U.  <i>CK: FWD AT</i>  <i>CL: FWD MT</i>  <i>CU: AWD AT</i>  <i>CV: AWD MT</i>  <i>CX: AWD MT (STi model)</i>  <i>CY: AWD MT (STi with Driver's control center differential model)</i></p>	Does the vehicle specification and ABSCM&H/U specification match?	Go to step 2.	Replace the ABSCM&H/U. <Ref. to ABS-6, ABS Control Module and Hydraulic Control Unit (ABSCM&H/U).>

## Diagnostics Procedure with Diagnostic Trouble Code (DTC)

### ABS (DIAGNOSTICS)

Step	Check	Yes	No
<b>2 CHECK GROUND SHORT OF HARNESS.</b> 1) Turn the ignition switch to OFF. 2) Disconnect the two connectors from TCM. 3) Disconnect the connector from ABSCM&H/U. 4) Measure the resistance between ABSCM&H/U connector and chassis ground. <i><b>Connector &amp; terminal</b></i> <i><b>LHD: (B301) No. 3 — Chassis ground:</b></i> <i><b>RHD: (F49) No. 3 — Chassis ground:</b></i>	Is the resistance more than 1 MΩ?	Go to step 3.	Repair the harness between TCM and ABSCM&H/U.
<b>3 CHECK TCM.</b> 1) Connect all connectors to TCM. 2) Turn the ignition switch to ON. 3) Measure the voltage between TCM connector terminal and chassis ground. <i><b>Connector &amp; terminal</b></i> <i><b>(B55) No. 21 (+) — Chassis ground (-):</b></i>	Is the voltage 10 — 15 V?	Go to step 5.	Go to step 4.
<b>4 CHECK AT.</b>	Is the AT functioning normally?	Replace the TCM.	Repair the AT.
<b>5 CHECK OPEN CIRCUIT OF HARNESS.</b> Measure the voltage between ABSCM&H/U connector and chassis ground. <i><b>Connector &amp; terminal</b></i> <i><b>LHD:</b></i> <i><b>(B301) No. 3 (+) — Chassis ground (-):</b></i> <i><b>(B301) No. 31 (+) — Chassis ground (-):</b></i> <i><b>RHD:</b></i> <i><b>(F49) No. 3 (+) — Chassis ground (-):</b></i> <i><b>(F49) No. 31 (+) — Chassis ground (-):</b></i>	Is the voltage 10 — 15 V?	Go to step 6.	Repair the harness/connector between TCM and ABSCM&H/U.
<b>6 CHECK POOR CONTACT IN CONNECTORS.</b>	Is there poor contact in connectors between TCM and ABSCM&H/U?	Repair the connector.	Go to step 7.
<b>7 CHECK ABSCM&amp;H/U.</b> 1) Connect all connectors. 2) Erase the memory. 3) Perform the inspection mode. 4) Read out the DTC.	Is the same DTC as in the current diagnosis still being output?	Replace the ABSCM only. <Ref. to ABS-6, ABS Control Module and Hydraulic Control Unit (ABSCM&H/U).>	Go to step 8.
<b>8 CHECK ANY OTHER DTC APPEARANCE.</b>	Are other DTCs being output?	Proceed with the diagnosis corresponding to DTC.	A temporary poor contact.

## X: DTC 44 ABS-AT CONTROL (CONTROLLED)

### DIAGNOSIS:

- Combination of AT control faults

### TROUBLE SYMPTOM:

- ABS does not operate.

### WIRING DIAGRAM:

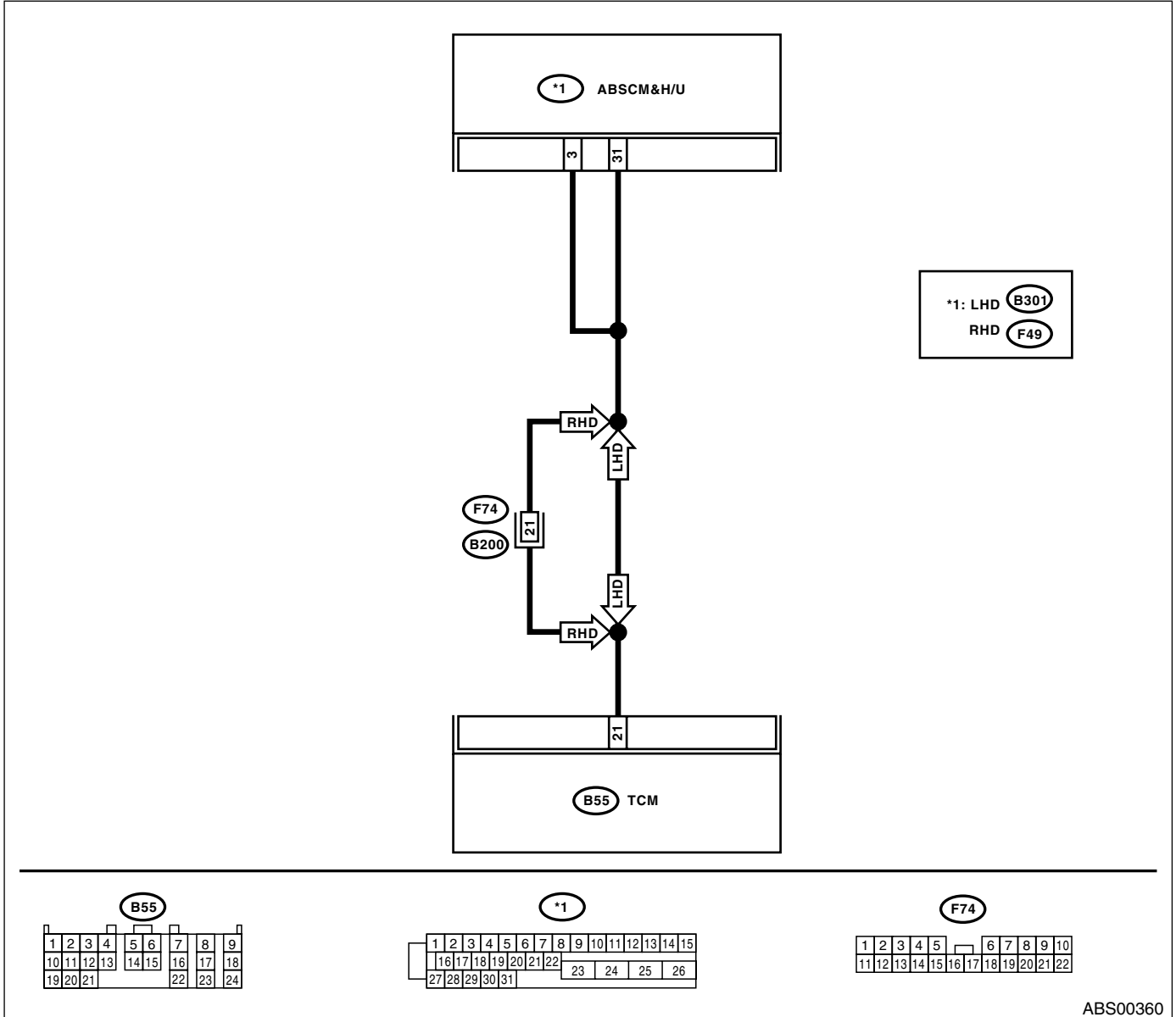

ABS00360



## Diagnostics Procedure with Diagnostic Trouble Code (DTC)

### ABS (DIAGNOSTICS)

Step	Check	Yes	No
<b>1 CHECK BATTERY SHORT OF HARNESS.</b> 1) Turn the ignition switch to OFF. 2) Disconnect all connectors from TCM. 3) Disconnect the connector from ABSCM&H/U. 4) Measure the voltage between ABSCM&H/U connector and chassis ground. <b>Connector &amp; terminal</b> <b>LHD: (B301) No. 3 (+) — Chassis ground (-):</b> <b>RHD: (F49) No. 3 (+) — Chassis ground (-):</b>	Is the voltage less than 1 V?	Go to step 2.	Repair the harness between TCM and ABSCM&H/U.
<b>2 CHECK BATTERY SHORT OF HARNESS.</b> 1) Turn the ignition switch to ON. 2) Measure the voltage between ABSCM&H/U connector and chassis ground. <b>Connector &amp; terminal</b> <b>LHD: (B301) No. 3 (+) — Chassis ground (-):</b> <b>RHD: (F49) No. 3 (+) — Chassis ground (-):</b>	Is the voltage less than 1 V?	Go to step 3.	Repair the harness between TCM and ABSCM&H/U.
<b>3 CHECK OPEN CIRCUIT OF HARNESS.</b> 1) Turn the ignition switch to OFF. 2) Connect all connectors to TCM. 3) Turn the ignition switch to ON. 4) Measure the voltage between ABSCM&H/U connector and chassis ground. <b>Connector &amp; terminal</b> <b>LHD:</b> <b>(B301) No. 3 (+) — Chassis ground (-):</b> <b>(B301) No. 31 (+) — Chassis ground (-):</b> <b>RHD:</b> <b>(F49) No. 3 (+) — Chassis ground (-):</b> <b>(F49) No. 31 (+) — Chassis ground (-):</b>	Is the voltage 10 — 15 V?	Go to step 4.	Repair the harness/connector between TCM and ABSCM&H/U.
<b>4 CHECK POOR CONTACT IN CONNECTORS.</b> Turn the ignition switch to OFF.	Is there poor contact in connectors between TCM and ABSCM&H/U?	Repair the connector.	Go to step 5.
<b>5 CHECK ABSCM&amp;H/U.</b> 1) Connect all connectors. 2) Erase the memory. 3) Perform the inspection mode. 4) Read out the DTC.	Is the same DTC as in current diagnosis still being output?	Replace the ABSCM only. <Ref. to ABS-6, ABS Control Module and Hydraulic Control Unit (ABSCM&H/U).>	Go to step 6.
<b>6 CHECK ANY OTHER DTC APPEARANCE.</b>	Are other DTCs being output?	Proceed with the diagnosis corresponding to DTC.	A temporary poor contact.

## Y: DTC 51 VALVE RELAY MALFUNCTION

### DIAGNOSIS:

- Faulty valve relay

### TROUBLE SYMPTOM:

- ABS does not operate.
- EBD may not operate.

### NOTE:

In addition to the ABS warning light, brake warning light illuminates when the EBD does not operate.

### WIRING DIAGRAM:

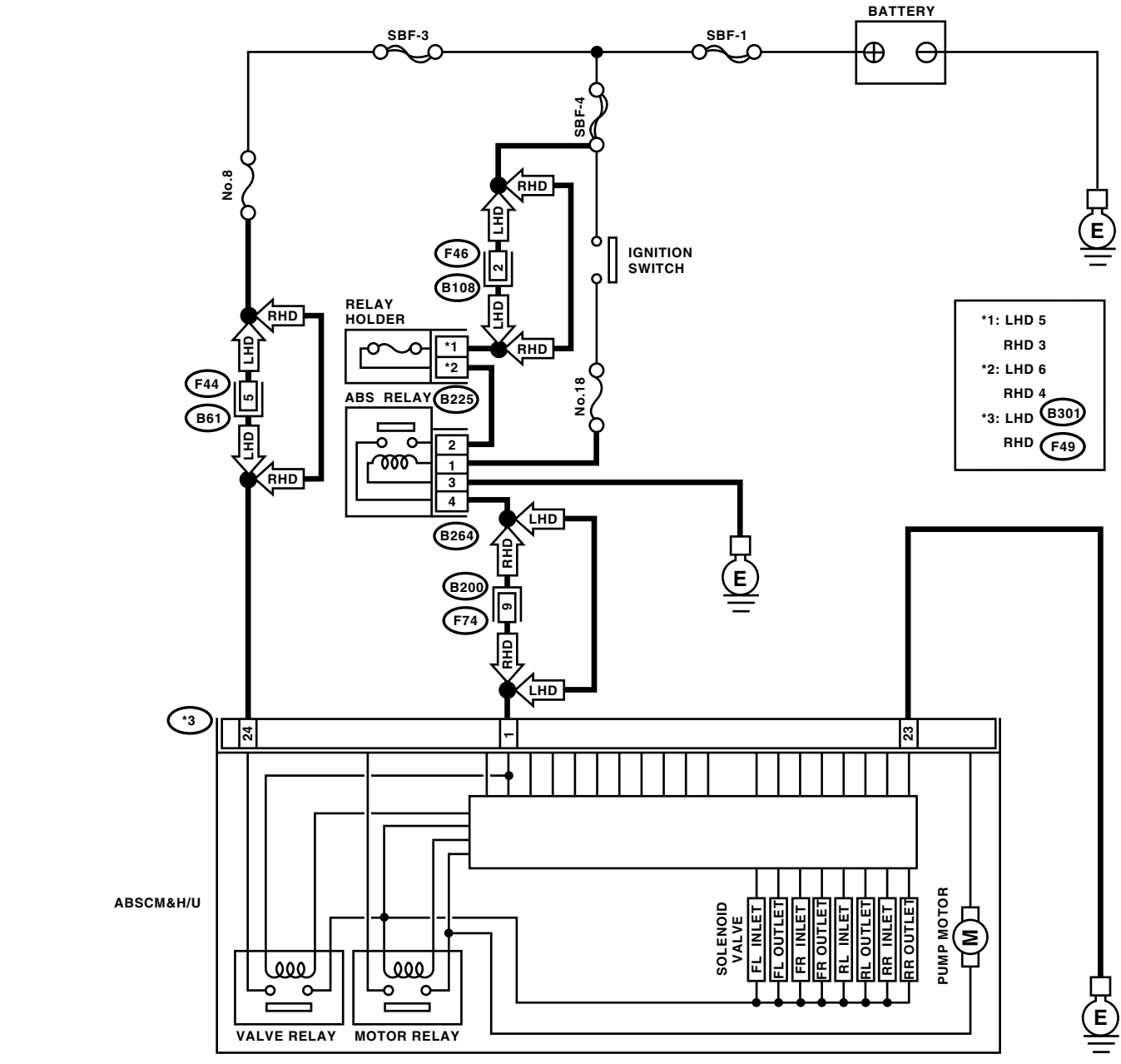

- \*1: LHD 5  
RHD 3
- \*2: LHD 6  
RHD 4
- \*3: LHD (B301)  
RHD (F49)

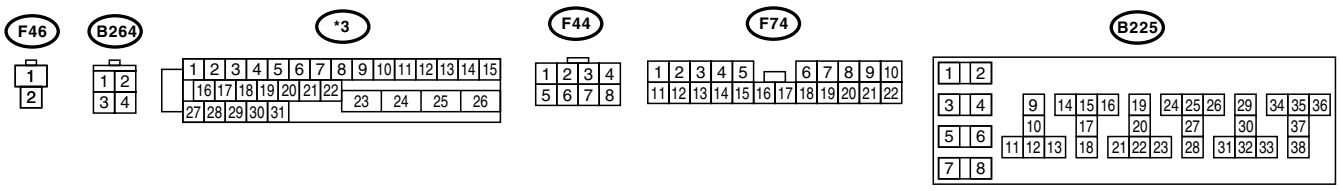

## Diagnostics Procedure with Diagnostic Trouble Code (DTC)

### ABS (DIAGNOSTICS)

Step	Check	Yes	No
<b>1 CHECK INPUT VOLTAGE OF ABSCM&amp;H/U.</b> 1) Turn the ignition switch to OFF. 2) Disconnect the connector from ABSCM&H/U. 3) Run the engine at idle. 4) Measure the voltage between ABSCM&H/U connector and chassis ground. <b>Connector &amp; terminal</b> <b>LHD:</b> (B301) No. 1 (+) — Chassis ground (-): (B301) No. 24 (+) — Chassis ground (-): <b>RHD:</b> (F49) No. 1 (+) — Chassis ground (-): (F49) No. 24 (+) — Chassis ground (-):	Is the voltage 10 — 15 V?	Go to step 2.	Repair the harness connector between battery and ABSCM&H/U.
<b>2 CHECK GROUND CIRCUIT OF ABSCM&amp;H/U.</b> 1) Turn the ignition switch to OFF. 2) Measure the resistance between ABSCM&H/U connector and chassis ground. <b>Connector &amp; terminal</b> <b>LHD: (B301) No. 23 — Chassis ground:</b> <b>RHD: (F49) No. 23 — Chassis ground:</b>	Is the resistance less than 0.5 Ω?	Go to step 3.	Repair the ABSCM&H/U ground harness.
<b>3 CHECK POOR CONTACT IN CONNECTORS.</b>	Is there poor contact in connectors between generator, battery and ABSCM&H/U?	Repair the connector.	Go to step 4.
<b>4 CHECK ABSCM&amp;H/U.</b> 1) Connect all connectors. 2) Erase the memory. 3) Perform the inspection mode. 4) Read out the DTC.	Is the same DTC as in current diagnosis still being output?	Replace the ABSCM only. <Ref. to ABS-6, ABS Control Module and Hydraulic Control Unit (ABSCM&H/U).>	Go to step 5.
<b>5 CHECK ANY OTHER DTC APPEARANCE.</b>	Are other DTCs being output?	Proceed with the diagnosis corresponding to DTC.	A temporary poor contact.

# Diagnostics Procedure with Diagnostic Trouble Code (DTC)

ABS (DIAGNOSTICS)

## Z: DTC 51 VALVE RELAY ON FAILURE

### DIAGNOSIS:

- Faulty valve relay

### TROUBLE SYMPTOM:

- ABS does not operate.

### WIRING DIAGRAM:

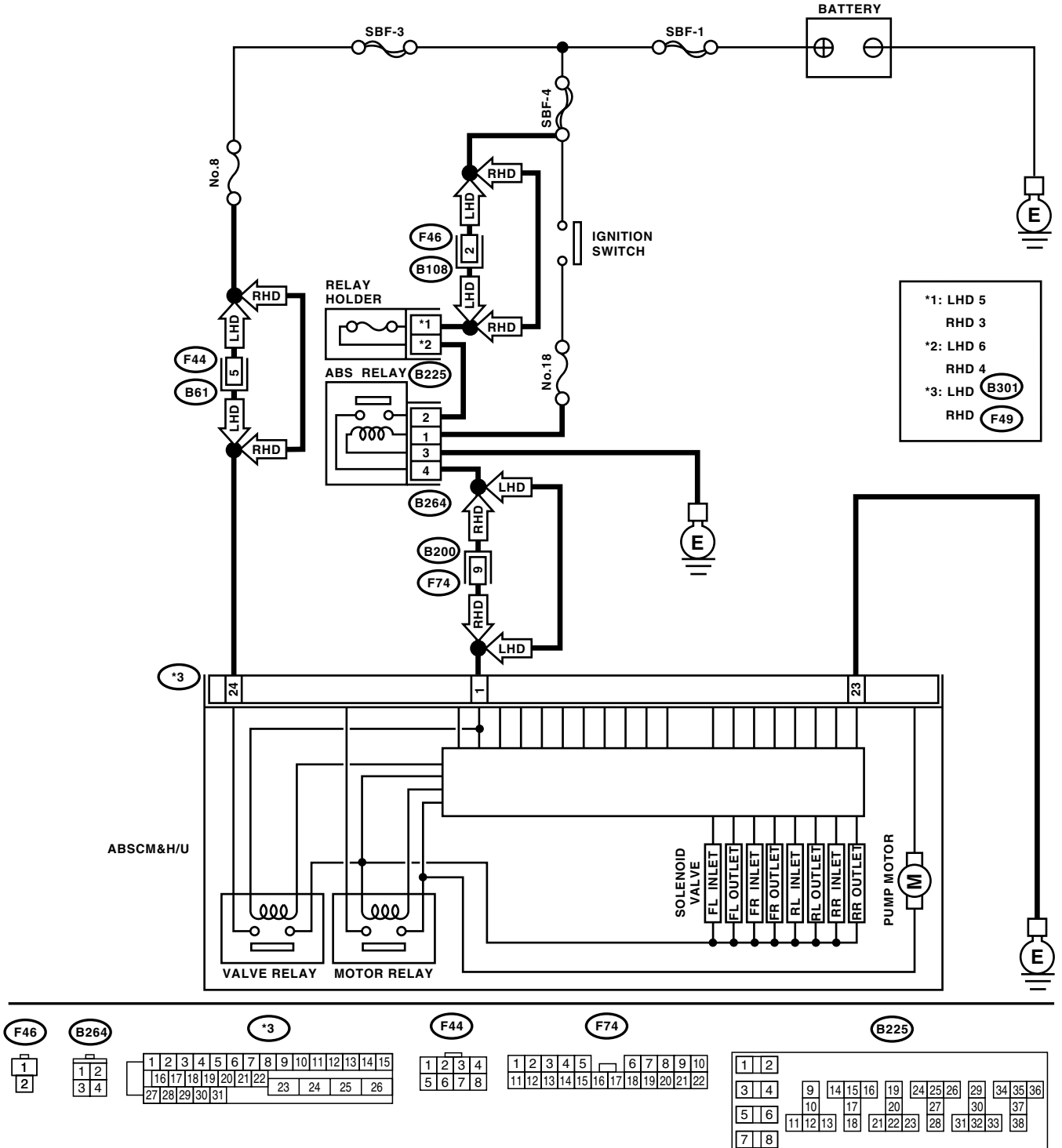

ABS00362

## Diagnostics Procedure with Diagnostic Trouble Code (DTC)

### ABS (DIAGNOSTICS)

Step	Check	Yes	No
<b>1 CHECK VALVE RELAY IN ABSCM&amp;H/U.</b> 1)Disconnect the connector from ABSCM&H/U. 2)Measure the resistance between ABSCM&H/U terminals. <b>Terminals</b> <b>No. 23 — No. 24:</b>	Is the resistance more than 1 MΩ?	Go to step 2.	Replace the ABSCM&H/U. <Ref. to ABS-6, ABS Control Module and Hydraulic Control Unit (ABSCM&H/U).>
<b>2 CHECK POOR CONTACT IN CONNECTORS.</b>	Is there poor contact in connectors between generator, battery and ABSCM&H/U?	Repair the connector.	Go to step 3.
<b>3 CHECK ABSCM&amp;H/U.</b> 1)Connect all connectors. 2)Erase the memory. 3)Perform the inspection mode. 4)Read out the DTC.	Is the same DTC as in current diagnosis still being output?	Replace the ABSCM only. <Ref. to ABS-6, ABS Control Module and Hydraulic Control Unit (ABSCM&H/U).>	Go to step 4.
<b>4 CHECK ANY OTHER DTC APPEARANCE.</b>	Are other DTCs being output?	Proceed with the diagnosis corresponding to DTC.	A temporary poor contact.

## AA:DTC 52 OPEN CIRCUIT IN MOTOR RELAY CIRCUIT

### DIAGNOSIS:

- Faulty motor
- Faulty motor relay
- Faulty harness connector

### TROUBLE SYMPTOM:

- ABS does not operate.

### WIRING DIAGRAM:

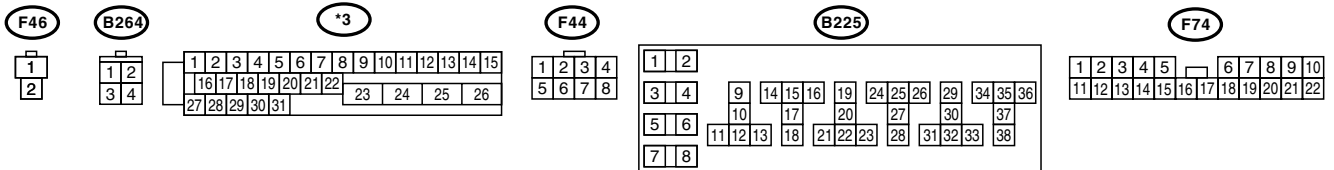
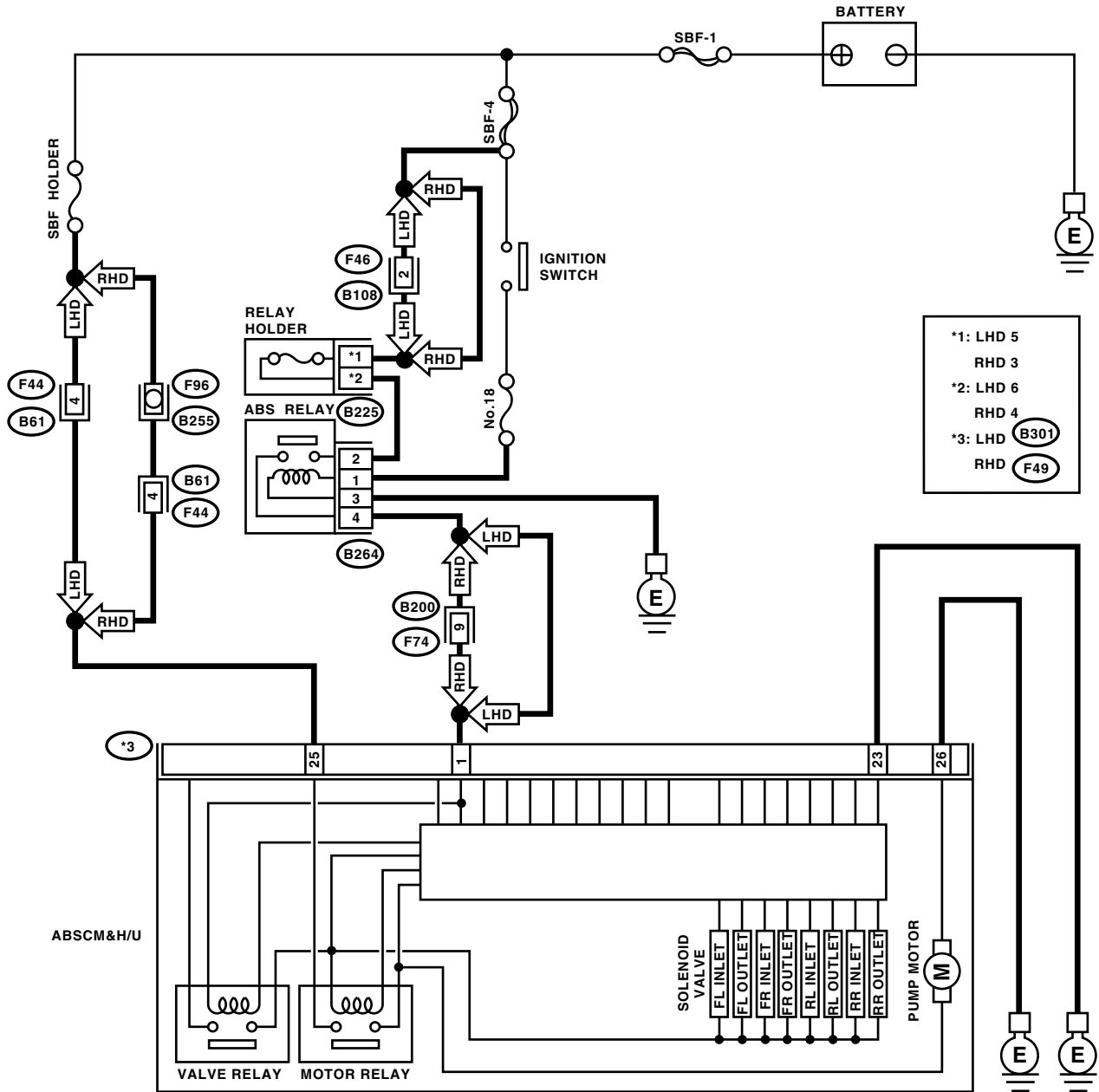

## Diagnostics Procedure with Diagnostic Trouble Code (DTC)

### ABS (DIAGNOSTICS)

Step	Check	Yes	No
<b>1 CHECK INPUT VOLTAGE OF ABSCM&amp;H/U.</b> 1) Turn the ignition switch to OFF. 2) Disconnect the connector from ABSCM&H/U. 3) Turn the ignition switch to ON. 4) Measure the voltage between ABSCM&H/U connector and chassis ground. <b>Connector &amp; terminal</b> <b>LHD: (B301) No. 25 (+) — Chassis ground (-):</b> <b>RHD: (F49) No. 25 (+) — Chassis ground (-):</b>	Is the voltage 10 — 15 V?	Go to step 2.	Repair the harness/connector between battery and ABSCM&H/U and check fuse SBF8.
<b>2 CHECK GROUND CIRCUIT OF MOTOR.</b> 1) Turn the ignition switch to OFF. 2) Measure the resistance between ABSCM&H/U connector and chassis ground. <b>Connector &amp; terminal</b> <b>LHD: (B301) No. 26 — Chassis ground:</b> <b>RHD: (F49) No. 26 — Chassis ground:</b>	Is the resistance less than 0.5 Ω?	Go to step 3.	Repair the ABSCM&H/U ground harness.
<b>3 CHECK MOTOR OPERATION.</b> Operate the sequence control. <Ref. to ABS-10, ABS Sequence Control.> <b>NOTE:</b> Use the diagnosis connector to operate sequence control.	Can motor revolution noise (buzz) be heard when carrying out the check sequence?	Go to step 4.	Replace the ABSCM&H/U. <Ref. to ABS-6, ABS Control Module and Hydraulic Control Unit (ABSCM&H/U).>
<b>4 CHECK POOR CONTACT IN CONNECTORS.</b> Turn the ignition switch to OFF.	Is there poor contact in connector between generator, battery and ABSCM&H/U?	Repair the connector.	Go to step 5.
<b>5 CHECK ABSCM&amp;H/U.</b> 1) Connect all connectors. 2) Erase the memory. 3) Perform the inspection mode. 4) Read out the DTC.	Is the same DTC as in current diagnosis still being output?	Replace the ABSCM only. <Ref. to ABS-6, ABS Control Module and Hydraulic Control Unit (ABSCM&H/U).>	Go to step 6.
<b>6 CHECK ANY OTHER DTC APPEARANCE.</b>	Are other DTCs being output?	Proceed with the diagnosis corresponding to DTC.	A temporary poor contact.

## AB:DTC 52 MOTOR RELAY ON FAILURE

### DIAGNOSIS:

- Faulty motor
- Faulty motor relay
- Faulty harness connector

### TROUBLE SYMPTOM:

- ABS does not operate.

### WIRING DIAGRAM:

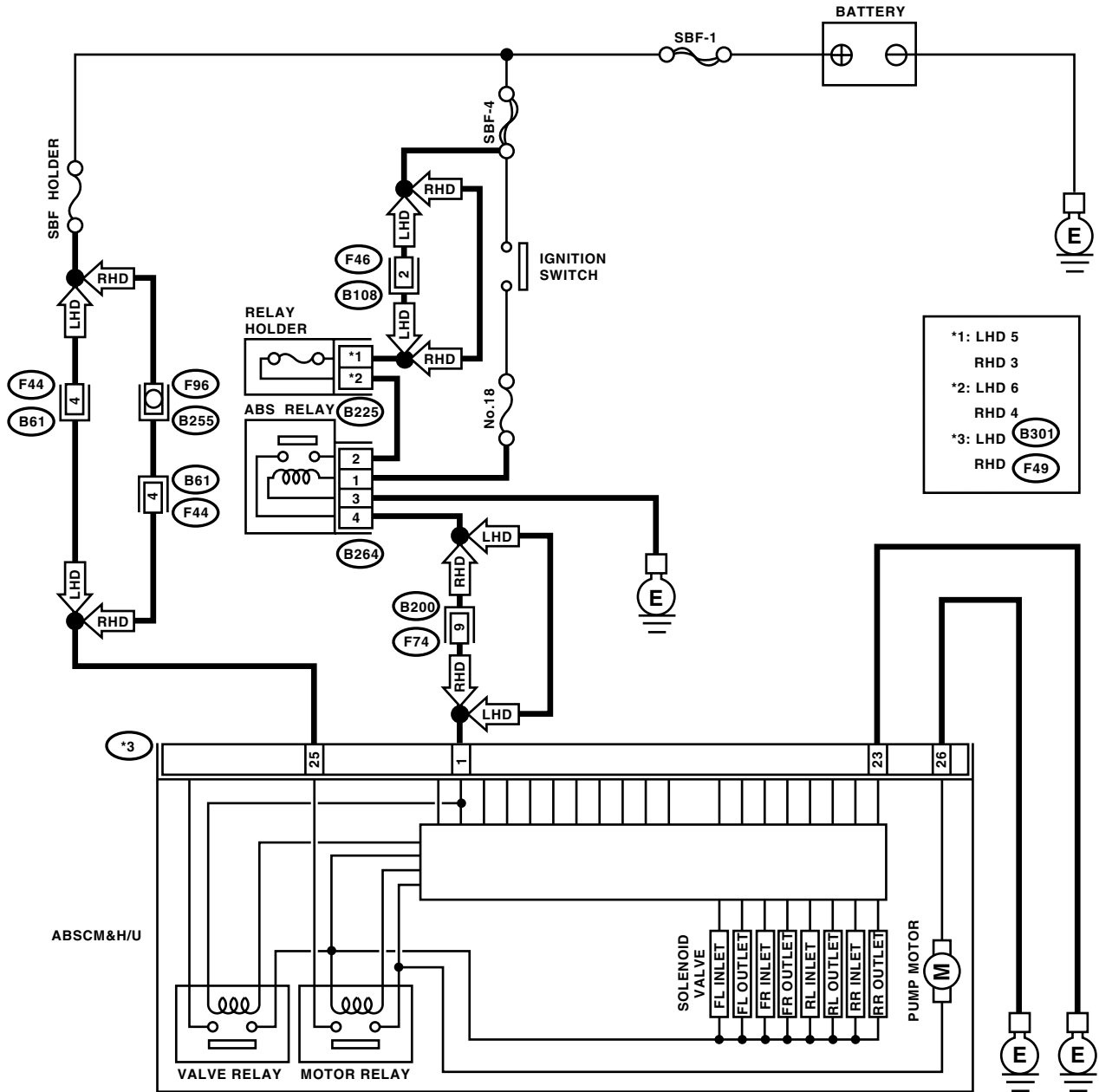

\*1: LHD 5  
RHD 3  
\*2: LHD 6  
RHD 4  
\*3: LHD (B301)  
RHD (F49)

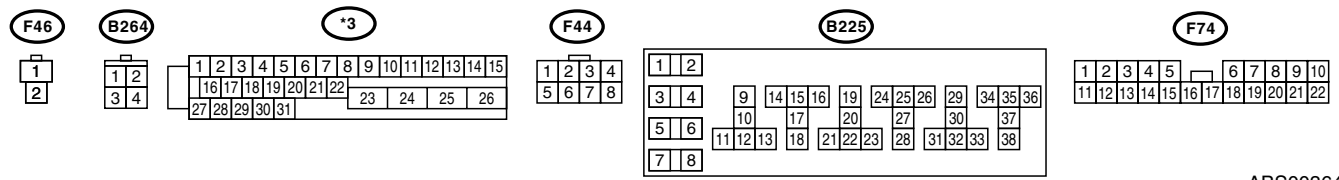



## Diagnostics Procedure with Diagnostic Trouble Code (DTC)

ABS (DIAGNOSTICS)

Step	Check	Yes	No
<b>1 CHECK MOTOR RELAY IN ABSCM&amp;H/U.</b> 1)Disconnect the connector from ABSCM&H/U. 2)Measure the resistance between ABSCM&H/U terminals. <b>Terminals</b> <b>No. 25 — No. 26:</b>	Is the resistance more than 1 MΩ?	Go to step 2.	Replace the ABSCM&H/U. <Ref. to ABS-6, ABS Control Module and Hydraulic Control Unit (ABSCM&H/U).>
<b>2 CHECK MOTOR OPERATION.</b> Operate the sequence control. <Ref. to ABS-10, ABS Sequence Control.> <b>NOTE:</b> Use the diagnosis connector to operate sequence control.	Can motor revolution noise (buzz) be heard when carrying out the sequence control?	Go to step 3.	Replace the ABSCM&H/U. <Ref. to ABS-6, ABS Control Module and Hydraulic Control Unit (ABSCM&H/U).>
<b>3 CHECK POOR CONTACT IN CONNECTORS.</b> Turn the ignition switch to OFF.	Is there poor contact in connector between generator, battery and ABSCM&H/U?	Repair the connector.	Go to step 4.
<b>4 CHECK ABSCM&amp;H/U.</b> 1)Connect all connectors. 2)Erase the memory. 3)Perform the inspection mode. 4)Read out the DTC.	Is the same DTC as in current diagnosis still being output?	Replace the ABSCM only. <Ref. to ABS-6, ABS Control Module and Hydraulic Control Unit (ABSCM&H/U).>	Go to step 5.
<b>5 CHECK ANY OTHER DTC APPEARANCE.</b>	Are other DTCs being output?	Proceed with the diagnosis corresponding to DTC.	A temporary poor contact. <b>NOTE:</b> Although the ABS warning light remains illuminating at this point, this is a normal condition. Vehicle must be driven at approx. 12 km/h (7.46 MPH) or faster to turn off ABS warning light. Make sure that the ABS warning light goes off after driving vehicle.

## AC:DTC 52 MOTOR MALFUNCTION

### DIAGNOSIS:

- Faulty motor
- Faulty motor relay
- Faulty harness connector

### TROUBLE SYMPTOM:

- ABS does not operate.

### WIRING DIAGRAM:

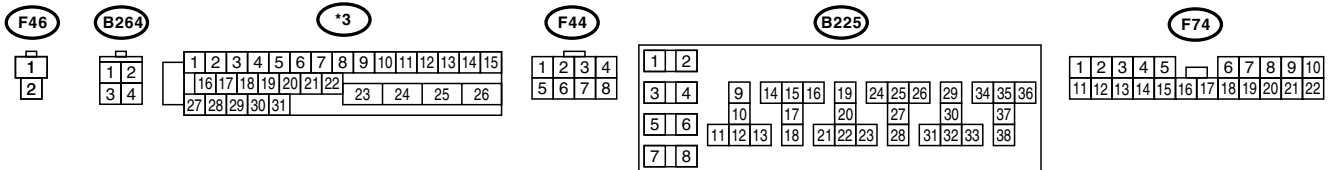
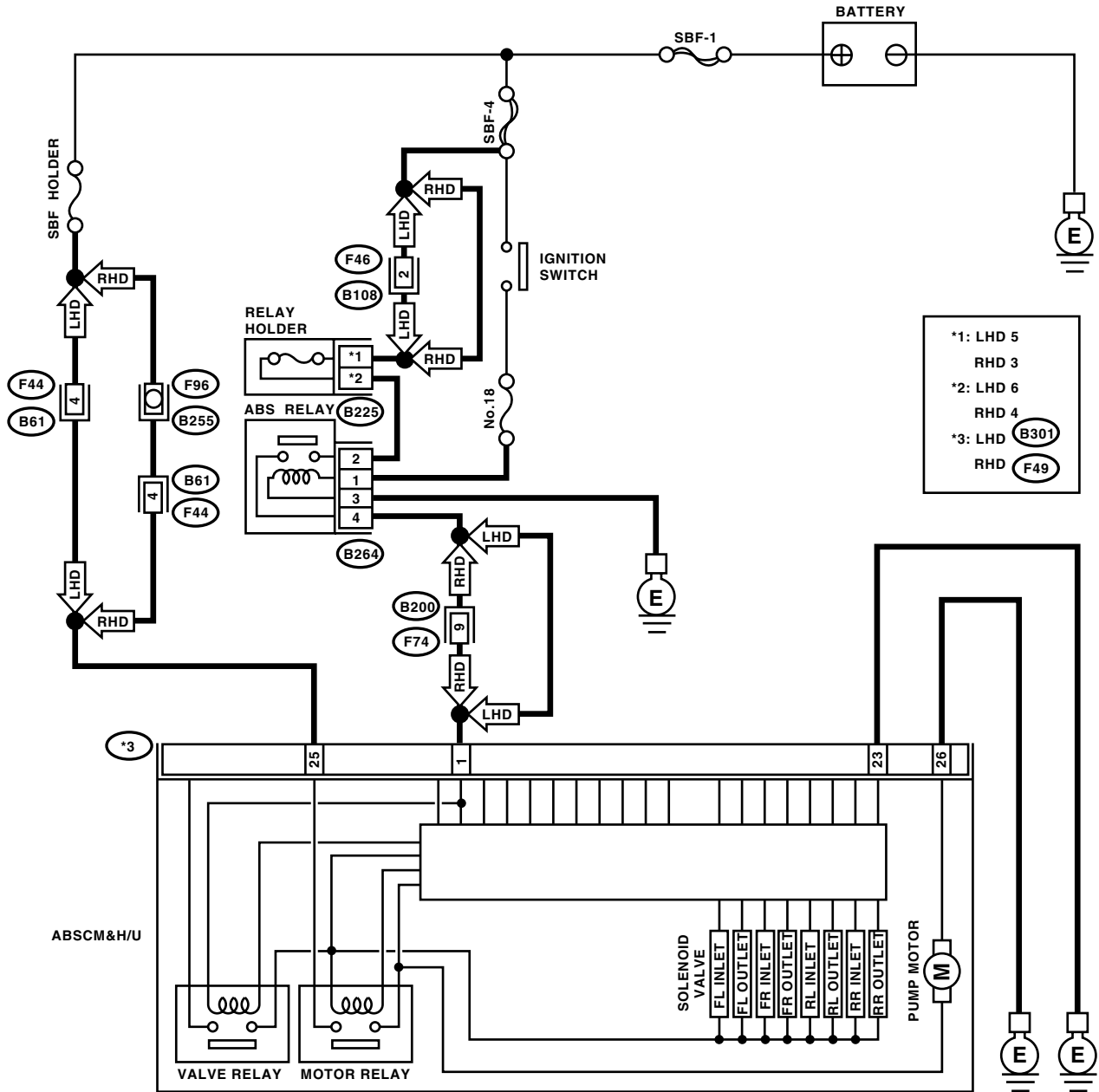

# Diagnostics Procedure with Diagnostic Trouble Code (DTC)

## ABS (DIAGNOSTICS)

Step	Check	Yes	No
<b>1 CHECK INPUT VOLTAGE OF ABSCM&amp;H/U.</b> 1) Turn the ignition switch to OFF. 2) Disconnect the connector from ABSCM&H/U. 3) Turn the ignition switch to ON. 4) Measure the voltage between ABSCM&H/U connector and chassis ground. <i>Connector &amp; terminal</i> <i>LHD: (B301) No. 25 (+) — Chassis ground (-):</i> <i>RHD: (F49) No. 25 (+) — Chassis ground (-):</i>	Is the voltage 10 — 15 V?	Go to step 2.	Repair the harness/connector between battery and ABSCM&H/U and check fuse SBF8.
<b>2 CHECK GROUND CIRCUIT OF MOTOR.</b> 1) Turn the ignition switch to OFF. 2) Measure the resistance between ABSCM&H/U connector and chassis ground. <i>Connector &amp; terminal</i> <i>LHD: (B301) No. 26 — Chassis ground:</i> <i>RHD: (F49) No. 26 — Chassis ground:</i>	Is the resistance less than 0.5 Ω?	Go to step 3.	Repair the ABSCM&H/U ground harness.
<b>3 CHECK INPUT VOLTAGE OF ABSCM&amp;H/U.</b> 1) Run the engine at idle. 2) Measure the voltage between ABSCM&H/U connector and chassis ground. <i>Connector &amp; terminal</i> <i>LHD: (B301) No. 1 (+) — Chassis ground (-):</i> <i>RHD: (F49) No. 1 (+) — Chassis ground (-):</i>	Is the voltage 10 — 15 V?	Go to step 4.	Repair the harness connector between battery, ignition switch and ABSCM&H/U.
<b>4 CHECK GROUND CIRCUIT OF ABSCM&amp;H/U.</b> 1) Turn the ignition switch to OFF. 2) Measure the resistance between ABSCM&H/U connector and chassis ground. <i>Connector &amp; terminal</i> <i>LHD: (B301) No. 23 — Chassis ground:</i> <i>RHD: (F49) No. 23 — Chassis ground:</i>	Is the resistance less than 0.5 Ω?	Go to step 5.	Repair the ABSCM&H/U ground harness.
<b>5 CHECK MOTOR OPERATION.</b> Operate the sequence control. <Ref. to ABS-10, ABS Sequence Control.> NOTE: Use the diagnosis connector to operate sequence control.	Can motor revolution noise (buzz) be heard when carrying out the sequence control?	Go to step 6.	Replace the ABSCM&H/U. <Ref. to ABS-6, ABS Control Module and Hydraulic Control Unit (ABSCM&H/U).>
<b>6 CHECK POOR CONTACT IN CONNECTORS.</b> Turn the ignition switch to OFF.	Is there poor contact in connector between generator, battery and ABSCM&H/U?	Repair the connector.	Go to step 7.
<b>7 CHECK ABSCM&amp;H/U.</b> 1) Connect all connectors. 2) Erase the memory. 3) Perform the inspection mode. 4) Read out the DTC.	Is the same DTC as in current diagnosis still being output?	Replace the ABSCM&H/U. <Ref. to ABS-6, ABS Control Module and Hydraulic Control Unit (ABSCM&H/U).>	Go to step 8.
<b>8 CHECK ANY OTHER DTC APPEARANCE.</b>	Are other DTCs being output?	Proceed with the diagnosis corresponding to DTC.	A temporary poor contact.

## AD:DTC 54 STOP LIGHT SWITCH SIGNAL CIRCUIT MALFUNCTION

### DIAGNOSIS:

- Faulty stop light switch

### TROUBLE SYMPTOM:

- ABS does not operate.

### WIRING DIAGRAM:

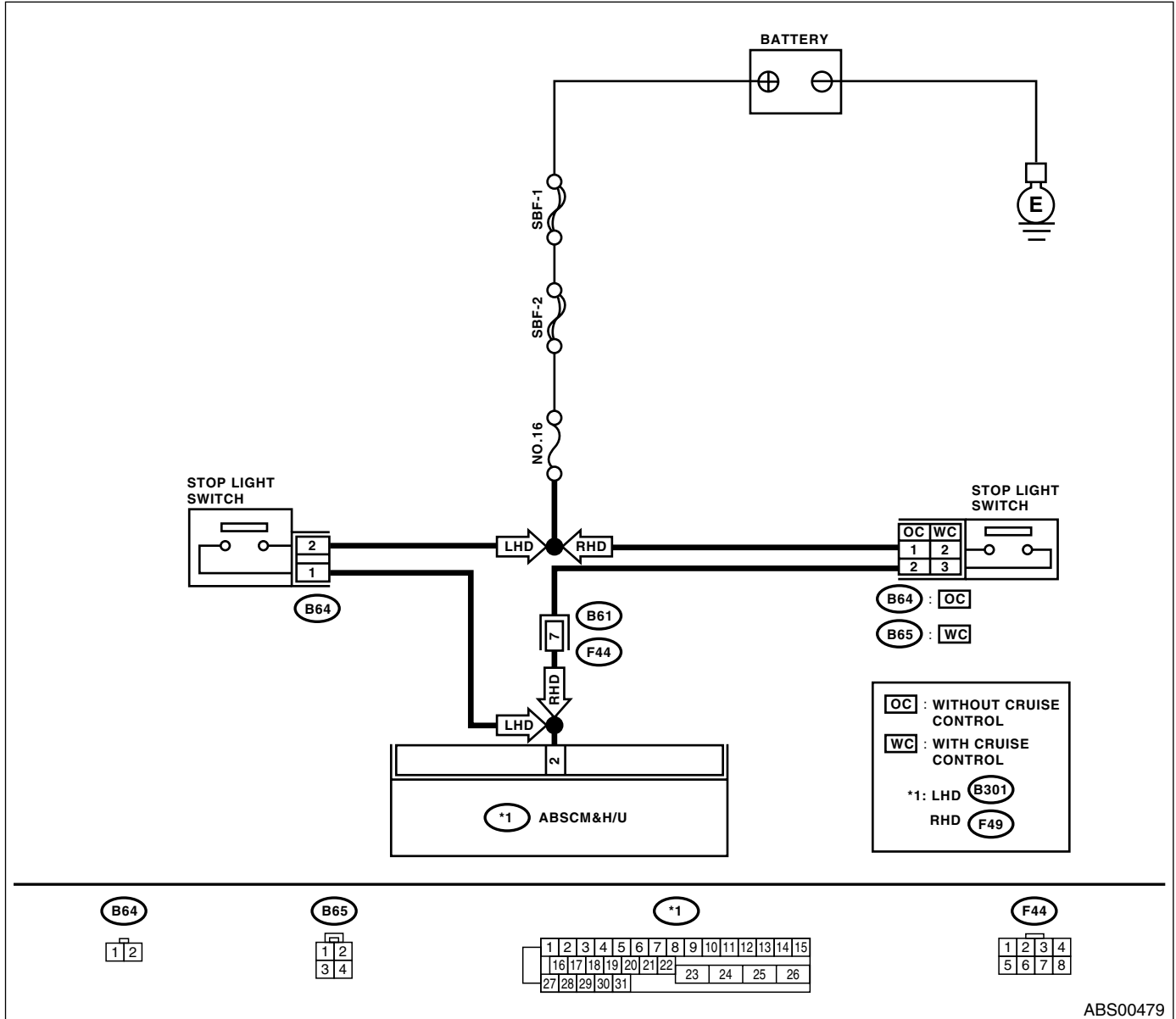

Step	Check	Yes	No
<b>1</b> <b>CHECK OUTPUT OF STOP LIGHT SWITCH USING SUBARU SELECT MONITOR.</b> 1) Select "Current data display & Save" on the Subaru Select Monitor. 2) Release the brake pedal. 3) Read the stop light switch output in Subaru Select Monitor data display.	Is the reading indicated on monitor display less than 1.5 V?	Go to step 2.	Go to step 3.

## Diagnostics Procedure with Diagnostic Trouble Code (DTC)

### ABS (DIAGNOSTICS)

Step	Check	Yes	No
<b>2 CHECK OUTPUT OF STOP LIGHT SWITCH USING SUBARU SELECT MONITOR.</b> 1)Depress the brake pedal. 2)Read the stop light switch output in Subaru Select Monitor data display.	Is the reading indicated on monitor display 10 — 15 V?	Go to step 5.	Go to step 3.
<b>3 CHECK IF STOP LIGHTS COME ON.</b> Depress the brake pedal.	Do the stop lights turn on?	Go to step 4.	Repair the stop lights circuit.
<b>4 CHECK OPEN CIRCUIT IN HARNESS.</b> 1)Turn the ignition switch to OFF. 2)Disconnect the connector from ABSCM&H/U. 3)Depress the brake pedal. 4)Measure the voltage between ABSCM&H/U connector and chassis ground. <b>Connector &amp; terminal</b> <b>LHD: (B301) No. 2 (+) — Chassis ground (-):</b> <b>RHD: (F49) No. 2 (+) — Chassis ground (-):</b>	Is the voltage 10 — 15 V?	Go to step 5.	Repair the harness between stop light switch and ABSCM&H/U connector.
<b>5 CHECK POOR CONTACT IN CONNECTORS.</b>	Is there poor contact in connector between stop light switch and ABSCM&H/U?	Go to step 6.	Repair the connector.
<b>6 CHECK ABSCM&amp;H/U.</b> 1)Connect all connectors. 2)Erase the memory. 3)Perform the inspection mode. 4)Read out the DTC.	Is the same DTC as in current diagnosis still being output?	Replace the ABSCM only. <Ref. to ABS-6, ABS Control Module and Hydraulic Control Unit (ABSCM&H/U).>	Go to step 7.
<b>7 CHECK ANY OTHER DTC APPEARANCE.</b>	Are other DTCs being output?	Proceed with the diagnosis corresponding to DTC.	A temporary poor contact.

## AE:DTC 56 OPEN OR SHORT CIRCUIT IN G SENSOR CIRCUIT

### DIAGNOSIS:

- Faulty G sensor output voltage

### TROUBLE SYMPTOM:

- ABS does not operate.

### WIRING DIAGRAM:

LHD MODEL

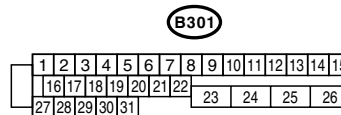
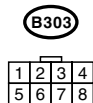
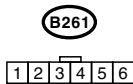
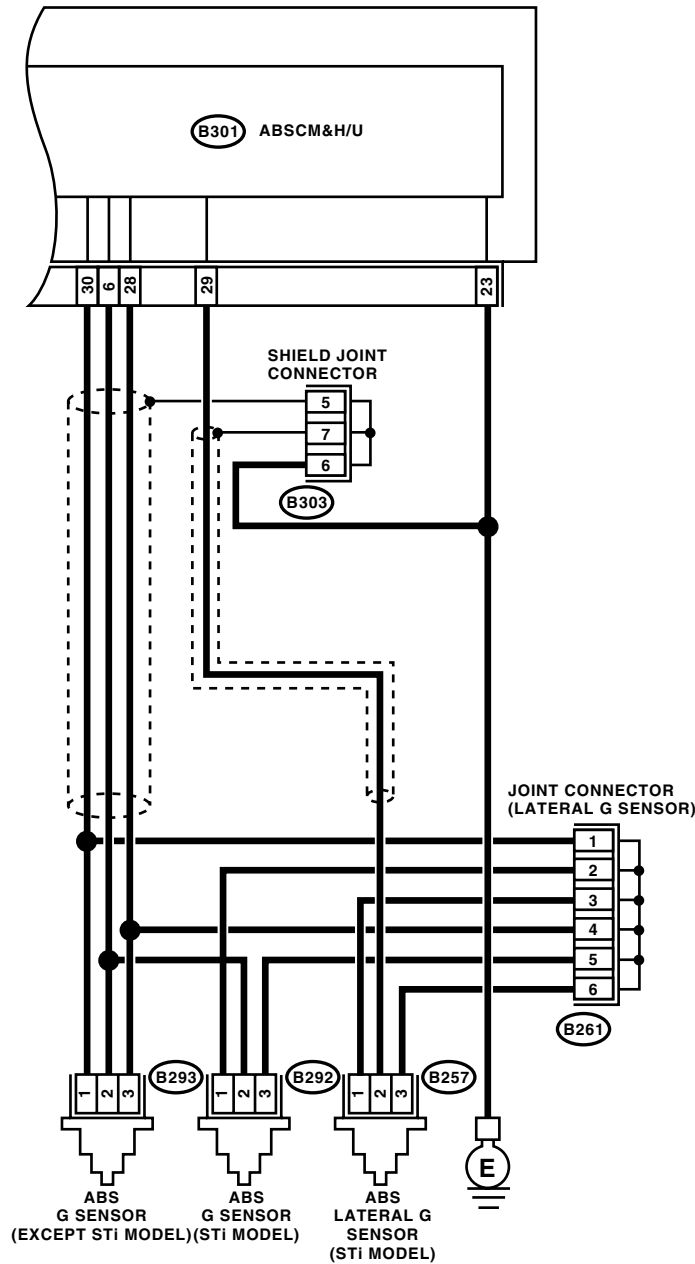

# Diagnostics Procedure with Diagnostic Trouble Code (DTC)

ABS (DIAGNOSTICS)

**RHD MODEL**

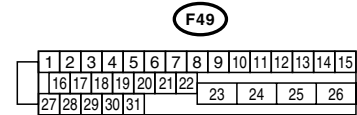
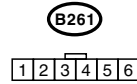
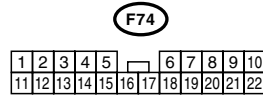
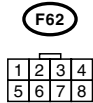
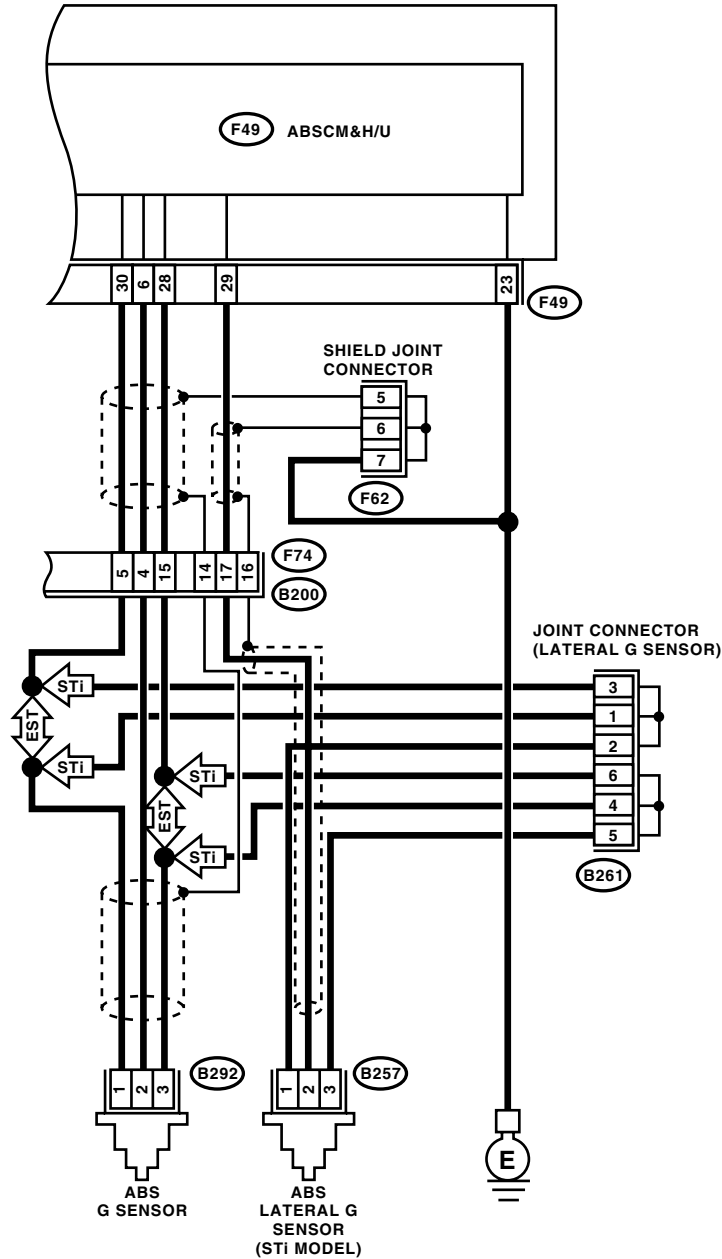

ABS00369

Step	Check	Yes	No
1	<p><b>CHECK OUTPUT OF G SENSOR USING SUBARU SELECT MONITOR.</b></p> <p>1) Select "Current data display &amp; Save" on the Subaru Select Monitor.</p> <p>2) Read the G sensor output in Subaru Select Monitor data display.</p>	Go to step 2.	Go to step 5.

# Diagnostics Procedure with Diagnostic Trouble Code (DTC)

ABS (DIAGNOSTICS)

Step	Check	Yes	No
<b>2</b>	<b>CHECK POOR CONTACT IN CONNECTORS.</b>	Is there poor contact in connector between ABSCM&H/U and G sensor?	Repair the connector. Go to step 3.
<b>3</b>	<b>CHECK ABSCM&amp;H/U.</b> 1)Connect all connectors. 2)Erase the memory. 3)Perform the inspection mode. 4)Read out the DTC.	Is the same DTC as in the current diagnosis still being output?	Replace the ABSCM only. <Ref. to ABS-6, ABS Control Module and Hydraulic Control Unit (ABSCM&H/U).> Go to step 4.
<b>4</b>	<b>CHECK ANY OTHER DTC APPEARANCE.</b>	Are other DTCs being output?	Proceed with the diagnosis corresponding to DTC. A temporary poor contact.
<b>5</b>	<b>CHECK INPUT VOLTAGE OF G SENSOR.</b> 1)Turn the ignition switch to OFF. 2)Remove the console box. 3)Remove the G sensor from vehicle. (Do not disconnect connector.) 4)Turn the ignition switch to ON. 5)Measure the voltage between G sensor connector terminals. <b>Connector &amp; terminal</b> <b>(B292) No. 1 (+) — No. 3 (-):</b>	Is the voltage 4.75 — 5.25 V?	Go to step 6. Repair the harness/connector between G sensor and ABSCM&H/U.
<b>6</b>	<b>CHECK OPEN CIRCUIT IN G SENSOR OUTPUT HARNESS AND GROUND HARNESS.</b> 1)Turn the ignition switch to OFF. 2)Disconnect the connector from ABSCM&H/U. 3)Measure the resistance between ABSCM&H/U connector terminals. <b>Connector &amp; terminal</b> <b>LHD: (B301) No. 6 — No. 28:</b> <b>RHD: (F49) No. 6 — No. 28:</b>	Is the resistance 5.0 — 5.6 kΩ?	Go to step 7. Repair the harness/connector between G sensor and ABSCM&H/U.
<b>7</b>	<b>CHECK GROUND SHORT IN G SENSOR OUTPUT HARNESS.</b> 1)Disconnect the connector from G sensor. 2)Measure the resistance between ABSCM&H/U connector and chassis ground. <b>Connector &amp; terminal</b> <b>LHD: (B301) No. 6 — Chassis ground:</b> <b>RHD: (F49) No. 6 — Chassis ground:</b>	Is the resistance more than 1 MΩ?	Go to step 8. Repair the harness between G sensor and ABSCM&H/U.
<b>8</b>	<b>CHECK G SENSOR.</b> 1)Connect the connector to G sensor. 2)Connect the connector to ABSCM&H/U. 3)Turn the ignition switch to ON. 4)Measure the voltage between G sensor connector terminals. <b>Connector &amp; terminal</b> <b>(B292) No. 2 (+) — No. 3 (-):</b>	Is the voltage 2.1 — 2.5 V when G sensor is in horizontal position?	Go to step 9. Replace the G sensor. <Ref. to ABS-21, G Sensor.>
<b>9</b>	<b>CHECK G SENSOR.</b> Measure the voltage between G sensor connector terminals. <b>Connector &amp; terminal</b> <b>(B292) No. 2 (+) — No. 3 (-):</b>	Is the voltage 3.7 — 4.1 V when G sensor is inclined forwards to 90°?	Go to step 10. Replace the G sensor. <Ref. to ABS-21, G Sensor.>
<b>10</b>	<b>CHECK G SENSOR.</b> Measure the voltage between G sensor connector terminals. <b>Connector &amp; terminal</b> <b>(B292) No. 2 (+) — No. 3 (-):</b>	Is the voltage 0.5 — 0.9 V when G sensor is inclined backwards to 90°?	Go to step 11. Replace the G sensor. <Ref. to ABS-21, G Sensor.>



## Diagnosics Procedure with Diagnostic Trouble Code (DTC)

ABS (DIAGNOSTICS)

Step	Check	Yes	No
<b>11</b> <b>CHECK POOR CONTACT IN CONNECTORS.</b> Turn the ignition switch to OFF.	Is there poor contact in connector between ABSCM&H/U and G sensor?	Repair the connector.	Go to step <b>12</b> .
<b>12</b> <b>CHECK ABSCM&amp;H/U.</b> 1)Connect all connectors. 2)Erase the memory. 3)Perform the inspection mode. 4)Read out the DTC.	Is the same DTC as in current diagnosis still being output?	Replace the ABSCM only. <Ref. to ABS-6, ABS Control Module and Hydraulic Control Unit (ABSCM&H/U).>	Go to step <b>13</b> .
<b>13</b> <b>CHECK ANY OTHER DTC APPEARANCE.</b>	Are other DTCs being output?	Proceed with the diagnosis corresponding to DTC.	A temporary poor contact.

## AF:DTC 56 BATTERY SHORT IN G SENSOR CIRCUIT

### DIAGNOSIS:

- Faulty G sensor output voltage

### TROUBLE SYMPTOM:

- ABS does not operate.

### WIRING DIAGRAM:

LHD MODEL

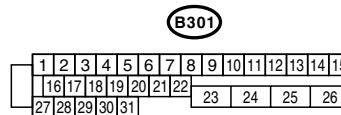
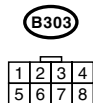
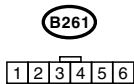
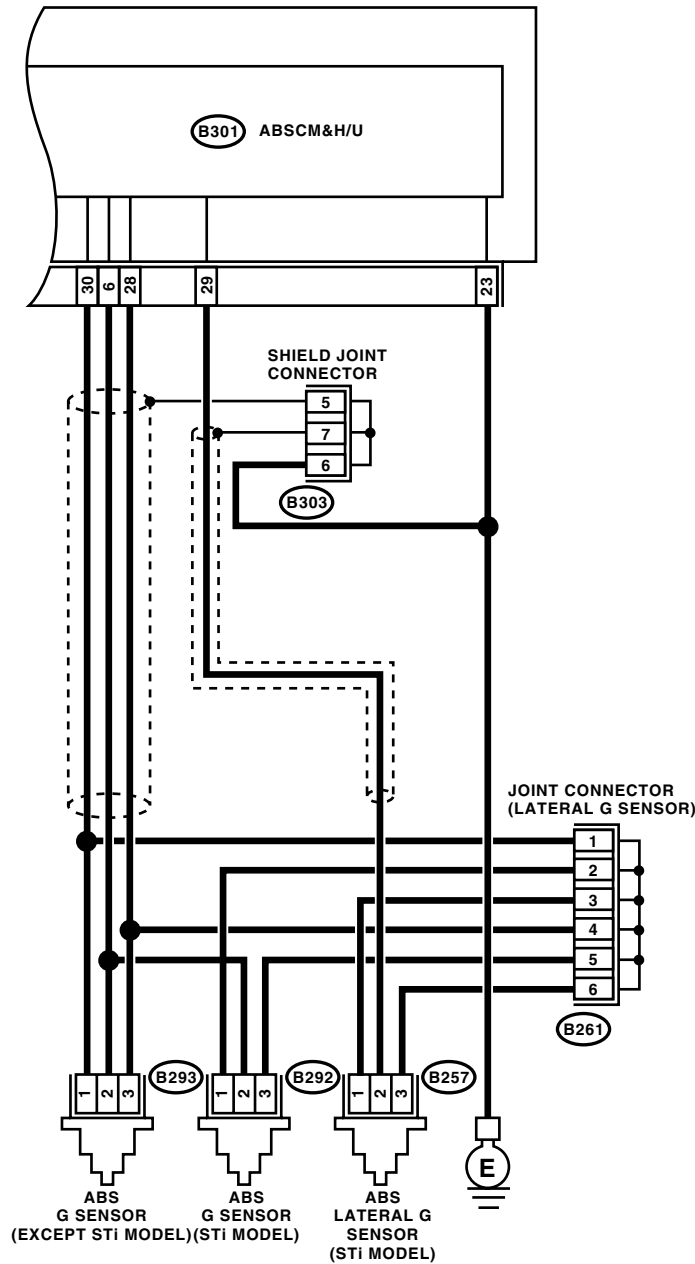

# Diagnostics Procedure with Diagnostic Trouble Code (DTC)

ABS (DIAGNOSTICS)

**RHD MODEL**

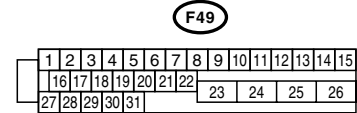
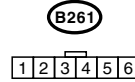
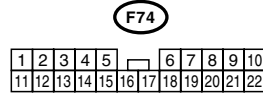
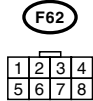
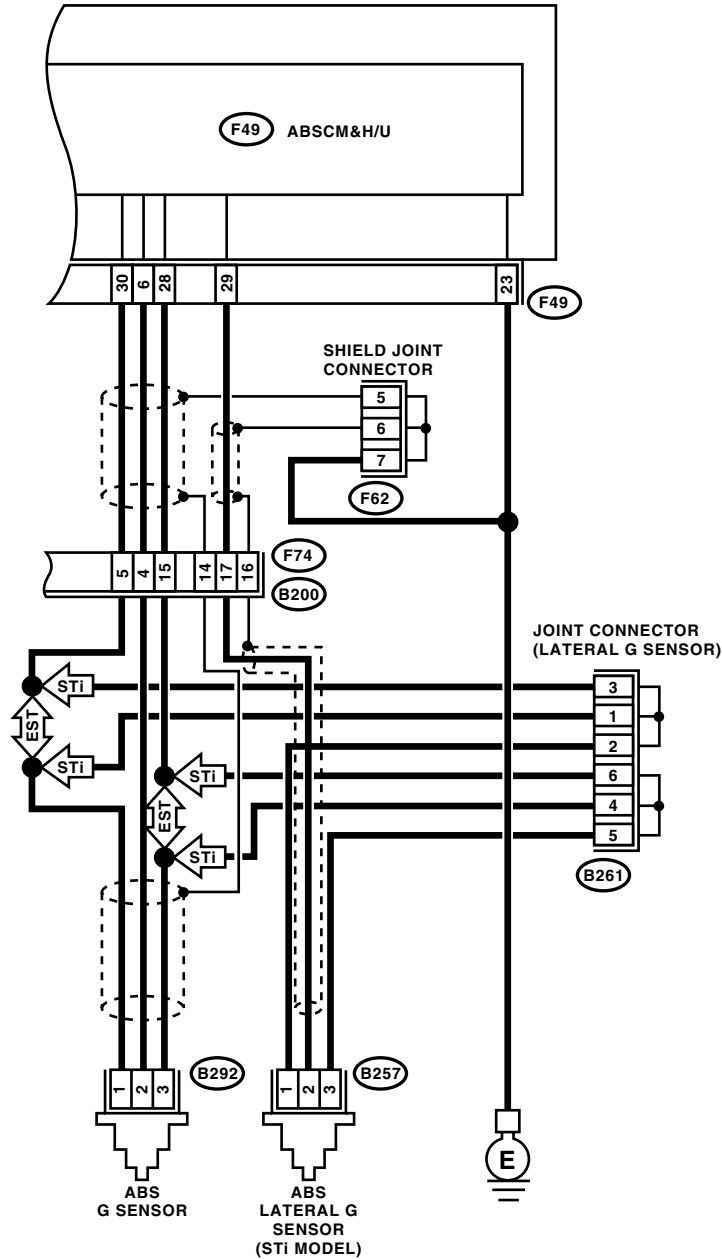

ABS00369

	Step	Check	Yes	No
<b>1</b>	<p><b>CHECK OUTPUT OF G SENSOR USING SUBARU SELECT MONITOR.</b></p> <p>1) Select "Current data display &amp; Save" on the Subaru Select Monitor.</p> <p>2) Read the G sensor output in Subaru Select Monitor data display.</p>	<p>Is the voltage 2.1 — 2.5 V when G sensor is in horizontal position?</p>	<p>Go to step 2.</p>	<p>Go to step 5.</p>

# Diagnostics Procedure with Diagnostic Trouble Code (DTC)

ABS (DIAGNOSTICS)

Step	Check	Yes	No	
<b>2</b>	<b>CHECK POOR CONTACT IN CONNECTORS.</b>	Is there poor contact in connector between ABSCM&H/U and G sensor?	Repair the connector.	Go to step 3.
<b>3</b>	<b>CHECK ABSCM&amp;H/U.</b> 1)Connect all connectors. 2)Erase the memory. 3)Perform the inspection mode. 4)Read out the DTC.	Is the same DTC as in current diagnosis still being output?	Replace the ABSCM only. <Ref. to ABS-6, ABS Control Module and Hydraulic Control Unit (ABSCM&H/U).>	Go to step 4.
<b>4</b>	<b>CHECK ANY OTHER DTC APPEARANCE.</b>	Are other DTCs being output?	Proceed with the diagnosis corresponding to DTC.	A temporary poor contact.
<b>5</b>	<b>CHECK FREEZE FRAME DATA.</b> 1)Select "Freeze frame data" on the Subaru Select Monitor. 2)Read front right wheel speed on the Subaru Select Monitor display.	Is the front right wheel speed on monitor display 0 km/h (0 MPH)?	Go to step 6.	Go to step 16.
<b>6</b>	<b>CHECK FREEZE FRAME DATA.</b> Read front left wheel speed on the Subaru Select Monitor display.	Is the front left wheel speed on monitor display 0 km/h (0 MPH)?	Go to step 7.	Go to step 16.
<b>7</b>	<b>CHECK FREEZE FRAME DATA.</b> Read rear right wheel speed on the Subaru Select Monitor display.	Is the rear right wheel speed on monitor display 0 km/h (0 MPH)?	Go to step 8.	Go to step 16.
<b>8</b>	<b>CHECK FREEZE FRAME DATA.</b> Read rear left wheel speed on the Subaru Select Monitor display.	Is the rear left wheel speed on monitor display 0 km/h (0 MPH)?	Go to step 9.	Go to step 16.
<b>9</b>	<b>CHECK FREEZE FRAME DATA.</b> Read G sensor output on the Subaru Select Monitor display.	Is the G sensor output on monitor display more than 3.65 V?	Go to step 10.	Go to step 16.
<b>10</b>	<b>CHECK OPEN CIRCUIT IN G SENSOR OUTPUT HARNESS AND GROUND HARNESS.</b> 1)Turn the ignition switch to OFF. 2)Disconnect the connector from ABSCM&H/U. 3)Measure the resistance between ABSCM&H/U connector terminals. <b>Connector &amp; terminal</b> <b>LHD: (B301) No. 6 — No. 28:</b> <b>RHD: (F49) No. 6 — No. 28:</b>	Is the resistance 4.3 — 4.9 kΩ?	Go to step 11.	Repair the harness/connector between G sensor and ABSCM&H/U.
<b>11</b>	<b>CHECK BATTERY SHORT OF HARNESS.</b> 1)Turn the ignition switch to OFF. 2)Remove the console box. 3)Disconnect the connector from G sensor. 4)Disconnect the connector from ABSCM&H/U. 5)Measure the voltage between ABSCM&H/U connector and chassis ground. <b>Connector &amp; terminal</b> <b>LHD: (B301) No. 6 (+) — Chassis ground (-):</b> <b>RHD: (F49) No. 6 (+) — Chassis ground (-):</b>	Is the voltage less than 1 V?	Go to step 12.	Repair the harness between G sensor and ABSCM&H/U.

# Diagnostics Procedure with Diagnostic Trouble Code (DTC)

## ABS (DIAGNOSTICS)

Step	Check	Yes	No
<b>12 CHECK BATTERY SHORT OF HARNESS.</b> 1) Turn the ignition switch to ON. 2) Measure the voltage between ABSCM&H/U connector and chassis ground. <i>Connector &amp; terminal</i> <i>LHD: (B301) No. 6 (+) — Chassis ground (-):</i> <i>RHD: (F49) No. 6 (+) — Chassis ground (-):</i>	Is the voltage less than 1 V?	Go to step 13.	Repair the harness between G sensor and ABSCM&H/U.
<b>13 CHECK POOR CONTACT IN CONNECTORS.</b>	Is there poor contact in connector between ABSCM&H/U and G sensor?	Repair the connector.	Go to step 14.
<b>14 CHECK ABSCM&amp;H/U.</b> 1) Connect all connectors. 2) Erase the memory. 3) Perform the inspection mode. 4) Read out the DTC.	Is the same DTC as in current diagnosis still being output?	Replace the ABSCM only. <Ref. to ABS-6, ABS Control Module and Hydraulic Control Unit (ABSCM&H/U).>	Go to step 15.
<b>15 CHECK ANY OTHER DTC APPEARANCE.</b>	Are other DTCs being output?	Proceed with the diagnosis corresponding to DTC.	A temporary poor contact.
<b>16 CHECK INPUT VOLTAGE OF G SENSOR.</b> 1) Turn the ignition switch to OFF. 2) Remove the console box. 3) Remove the G sensor from vehicle. (Do not disconnect connector.) 4) Turn the ignition switch to ON. 5) Measure the voltage between G sensor connector terminals. <i>Connector &amp; terminal</i> <i>(B292) No. 1 (+) — No. 3 (-):</i>	Is the voltage 4.75 — 5.25 V?	Go to step 17.	Repair the harness/connector between G sensor and ABSCM&H/U.
<b>17 CHECK OPEN CIRCUIT IN G SENSOR OUTPUT HARNESS AND GROUND HARNESS.</b> 1) Turn the ignition switch to OFF. 2) Disconnect the connector from ABSCM&H/U. 3) Measure the resistance between ABSCM&H/U connector terminals. <i>Connector &amp; terminal</i> <i>LHD: (B301) No. 6 — No. 28:</i> <i>RHD: (F49) No. 6 — No. 28:</i>	Is the resistance 5.0 — 5.6 kΩ?	Go to step 18.	Repair the harness/connector between G sensor and ABSCM&H/U.
<b>18 CHECK G SENSOR.</b> 1) Connect the connector to G sensor. 2) Connect the connector to ABSCM&H/U. 3) Turn the ignition switch to ON. 4) Measure the voltage between G sensor connector terminals. <i>Connector &amp; terminal</i> <i>(B292) No. 2 (+) — No. 3 (-):</i>	Is the voltage 2.1 — 2.5 V when G sensor is in horizontal position?	Go to step 19.	Replace the G sensor. <Ref. to ABS-21, G Sensor.>
<b>19 CHECK G SENSOR.</b> Measure the voltage between G sensor connector terminals. <i>Connector &amp; terminal</i> <i>(B292) No. 2 (+) — No. 3 (-):</i>	Is the voltage 3.7 — 4.1 V when G sensor is inclined forwards to 90°?	Go to step 20.	Replace the G sensor. <Ref. to ABS-21, G Sensor.>

# Diagnostics Procedure with Diagnostic Trouble Code (DTC)

ABS (DIAGNOSTICS)

Step	Check	Yes	No
<b>20 CHECK G SENSOR.</b> Measure the voltage between G sensor connector terminals. <i>Connector &amp; terminal</i> <i>(B292) No. 2 (+) — No. 3 (-):</i>	Is the voltage 0.5 — 0.9 V when G sensor is inclined backwards to 90°?	Go to step 21.	Replace the G sensor. <Ref. to ABS-21, G Sensor.>
<b>21 CHECK POOR CONTACT IN CONNECTORS.</b> Turn the ignition switch to OFF.	Is there poor contact in connector between ABSCM&H/U and G sensor?	Repair the connector.	Go to step 22.
<b>22 CHECK ABSCM&amp;H/U.</b> 1)Connect all connectors. 2)Erase the memory. 3)Perform the inspection mode. 4)Read out the DTC.	Is the same DTC as in current diagnosis still being output?	Replace the ABSCM only. <Ref. to ABS-6, ABS Control Module and Hydraulic Control Unit (ABSCM&H/U).>	Go to step 23.
<b>23 CHECK ANY OTHER DTC APPEARANCE.</b>	Are other DTCs being output?	Proceed with the diagnosis corresponding to DTC.	A temporary poor contact.

# Diagnostics Procedure with Diagnostic Trouble Code (DTC)

ABS (DIAGNOSTICS)

## AG:DTC 56 ABNORMAL G SENSOR HIGH $\mu$ OUTPUT

### DIAGNOSIS:

- Faulty G sensor output voltage

### TROUBLE SYMPTOM:

- ABS does not operate.

### WIRING DIAGRAM:

LHD MODEL

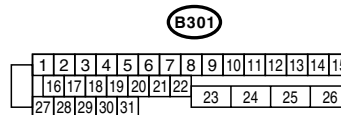
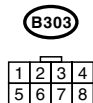
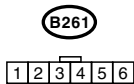
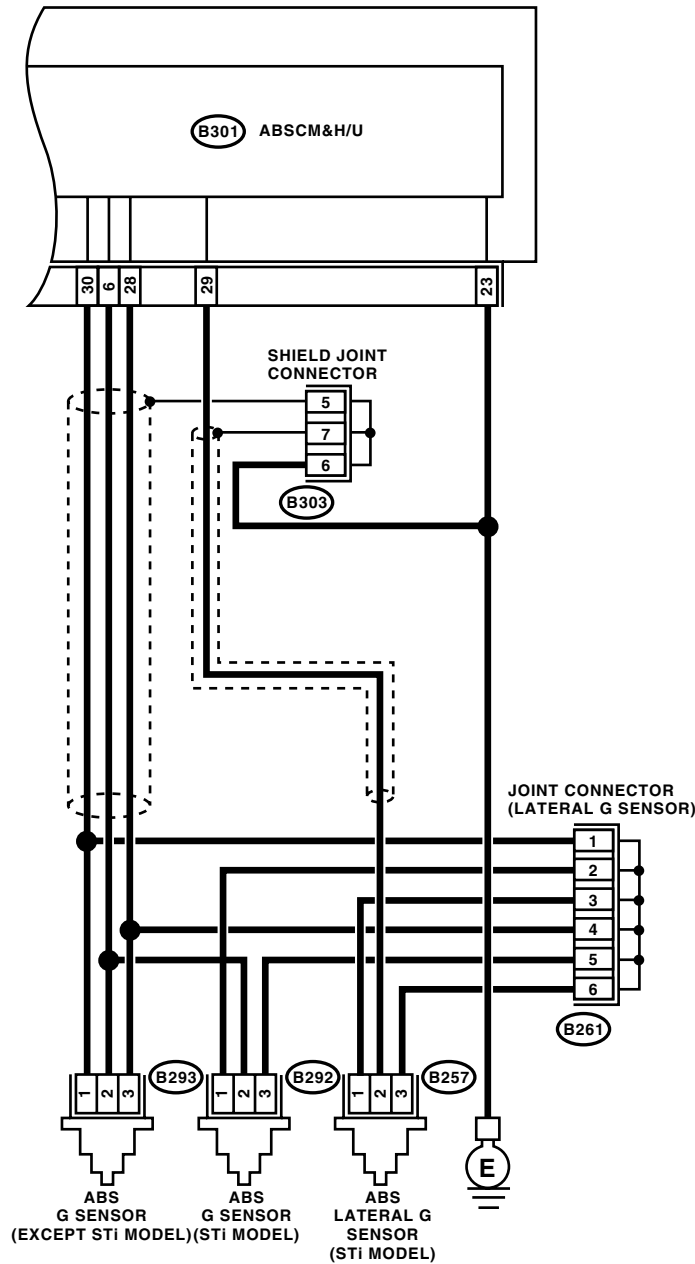

ABS00368

# Diagnostics Procedure with Diagnostic Trouble Code (DTC)

ABS (DIAGNOSTICS)

## RHD MODEL

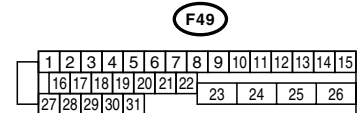
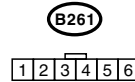
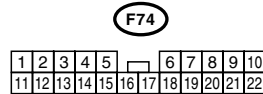
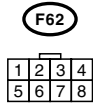
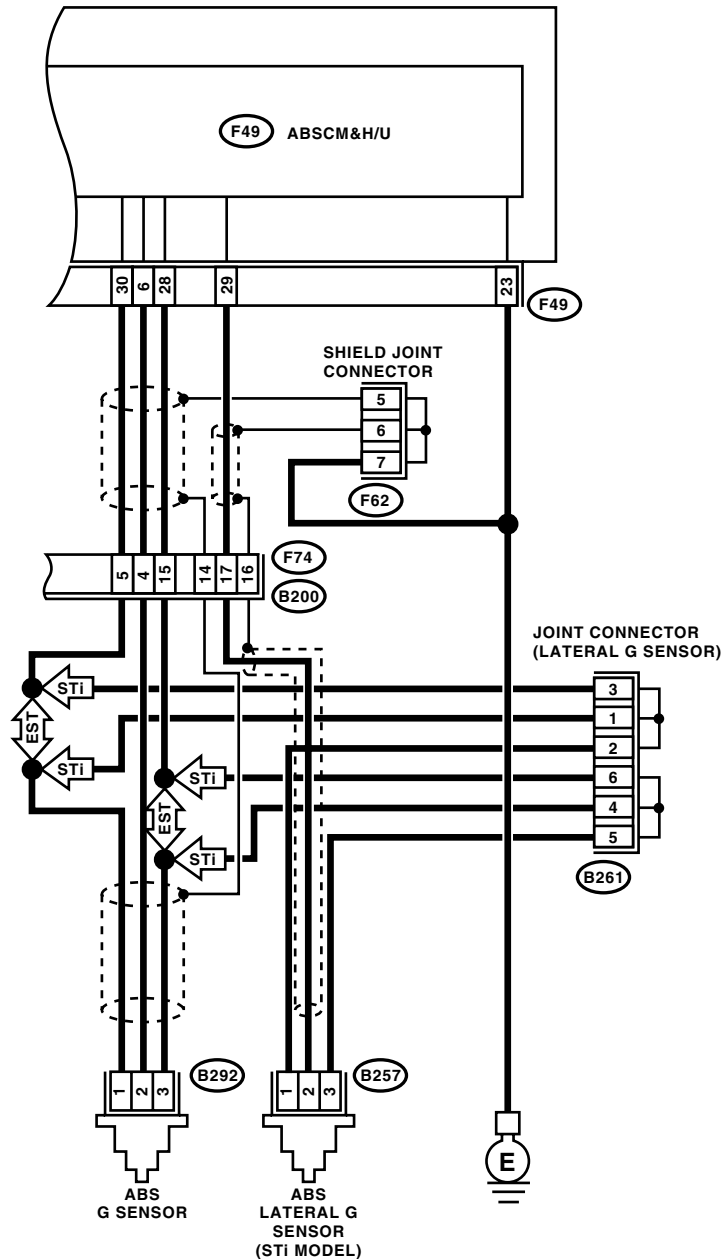

ABS00369

Step	Check	Yes	No
1	<p><b>CHECK OUTPUT OF G SENSOR USING SUBARU SELECT MONITOR.</b></p> <p>1) Select "Current data display &amp; Save" on the Subaru Select Monitor.</p> <p>2) Read G sensor output on the Subaru Select Monitor display.</p>	Go to step 2.	Go to step 6.



## Diagnostics Procedure with Diagnostic Trouble Code (DTC)

### ABS (DIAGNOSTICS)

Step	Check	Yes	No
<b>2</b>	<b>CHECK POOR CONTACT IN CONNECTORS.</b> Turn the ignition switch to OFF.	Is there poor contact in connector between ABSCM&H/U and G sensor?	Repair the connector.  Go to step <b>3</b> .
<b>3</b>	<b>CHECK ABSCM&amp;H/U.</b> 1)Connect all connectors. 2)Erase the memory. 3)Perform the inspection mode. 4)Read out the DTC.	Is the same DTC as in current diagnosis still being output?	Replace the ABSCM only. <Ref. to ABS-6, ABS Control Module and Hydraulic Control Unit (ABSCM&H/U).>  Go to step <b>4</b> .
<b>4</b>	<b>CHECK ANY OTHER DTC APPEARANCE.</b>	Are other DTCs being output?	Proceed with the diagnosis corresponding to DTC.  A temporary poor contact.
<b>5</b>	<b>CHECK OPEN CIRCUIT IN G SENSOR OUTPUT HARNESS AND GROUND HARNESS.</b> 1)Turn the ignition switch to OFF. 2)Disconnect the connector from ABSCM&H/U. 3)Measure the resistance between ABSCM&H/U connector terminals. <b>Connector &amp; terminal</b> <b>LHD: (B301) No. 6 — No. 28:</b> <b>RHD: (F49) No. 6 — No. 28:</b>	Is the resistance 5.0 — 5.6 kΩ?	Go to step <b>6</b> .  Repair the harness/connector between G sensor and ABSCM&H/U.
<b>6</b>	<b>CHECK GROUND SHORT OF HARNESS.</b> Measure the resistance between ABSCM&H/U connector and chassis ground. <b>Connector &amp; terminal</b> <b>LHD: (B301) No. 28 — Chassis ground:</b> <b>RHD: (F49) No. 28 — Chassis ground:</b>	Is the resistance more than 1 MΩ?	Go to step <b>7</b> .  Repair the harness between G sensor and ABSCM only. Replace the ABSCM&H/U. <Ref. to ABS-6, ABS Control Module and Hydraulic Control Unit (ABSCM&H/U).>
<b>7</b>	<b>CHECK G SENSOR.</b> 1)Remove the console box. 2)Remove the G sensor from vehicle. 3)Connect the connector to G sensor. 4)Connect the connector to ABSCM&H/U. 5)Turn the ignition switch to ON. 6)Measure the voltage between G sensor connector terminals. <b>Connector &amp; terminal</b> <b>(B292) No. 2 (+) — No. 3 (-):</b>	Is the voltage 2.1 — 2.5 V when G sensor is in horizontal position?	Go to step <b>8</b> .  Replace the G sensor. <Ref. to ABS-21, G Sensor.>
<b>8</b>	<b>CHECK G SENSOR.</b> Measure the voltage between G sensor connector terminals. <b>Connector &amp; terminal</b> <b>(B292) No. 2 (+) — No. 3 (-):</b>	Is the voltage 3.7 — 4.1 V when G sensor is inclined forwards to 90°?	Go to step <b>9</b> .  Replace the G sensor. <Ref. to ABS-21, G Sensor.>
<b>9</b>	<b>CHECK G SENSOR.</b> Measure the voltage between G sensor connector terminals. <b>Connector &amp; terminal</b> <b>(B292) No. 2 (+) — No. 3 (-):</b>	Is the voltage 0.5 — 0.9 V when G sensor is inclined backwards to 90°?	Go to step <b>10</b> .  Replace the G sensor. <Ref. to ABS-21, G Sensor.>

# Diagnosics Procedure with Diagnostic Trouble Code (DTC)

ABS (DIAGNOSTICS)

Step	Check	Yes	No
<b>10</b> <b>CHECK ABSCM&amp;H/U.</b> 1)Turn the ignition switch to OFF. 2)Connect all connectors. 3)Erase the memory. 4)Perform the inspection mode. 5)Read out the DTC.	Is the same DTC as in current diagnosis still being output?	Replace the ABSCM only. <Ref. to ABS-6, ABS Control Module and Hydraulic Control Unit (ABSCM&H/U).>	Go to step <b>11</b> .
<b>11</b> <b>CHECK ANY OTHER DTC APPEARANCE.</b>	Are other DTCs being output?	Proceed with the diagnosis corresponding to DTC.	A temporary poor contact.

# Diagnostics Procedure with Diagnostic Trouble Code (DTC)

ABS (DIAGNOSTICS)

## AH:DTC 56 DETECTION OF G SENSOR STICK

### DIAGNOSIS:

- Faulty G sensor output voltage

### TROUBLE SYMPTOM:

- ABS does not operate.

### WIRING DIAGRAM:

LHD MODEL

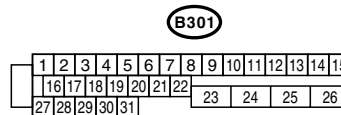
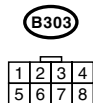
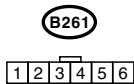
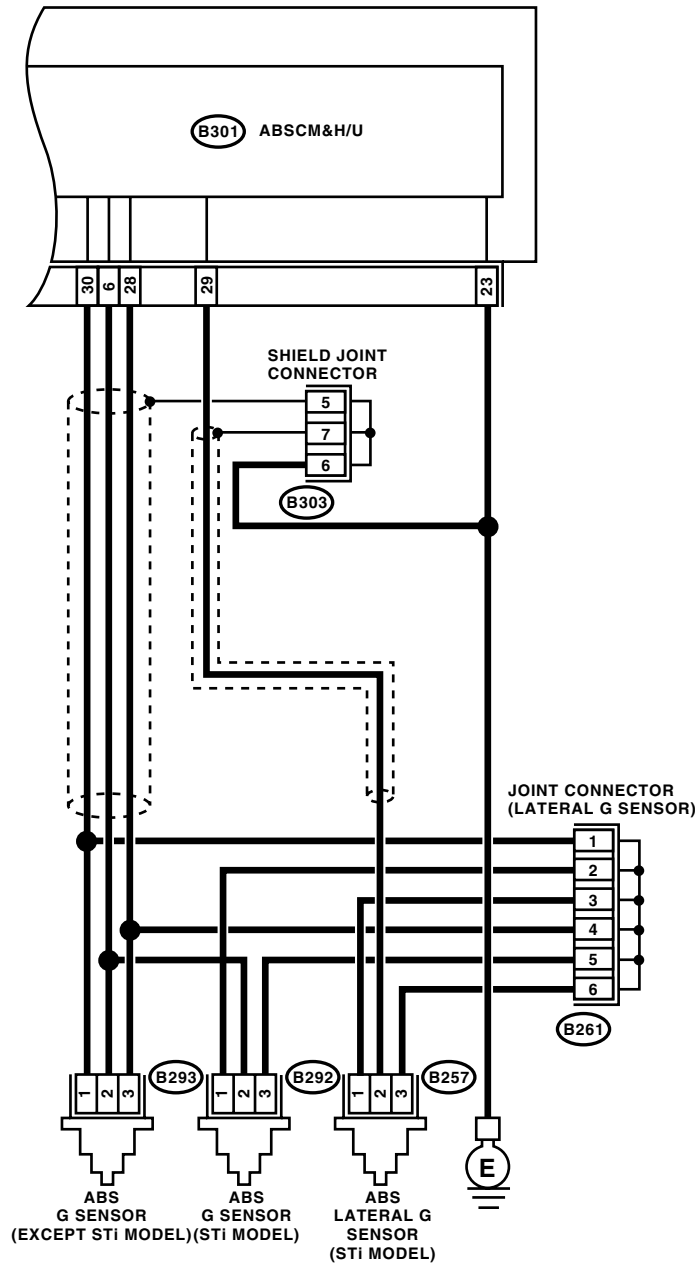

ABS00368

# Diagnostics Procedure with Diagnostic Trouble Code (DTC)

ABS (DIAGNOSTICS)

## RHD MODEL

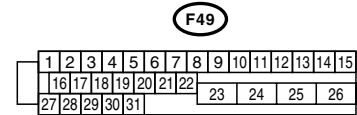
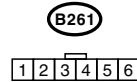
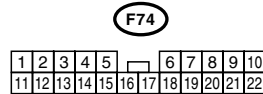
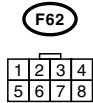
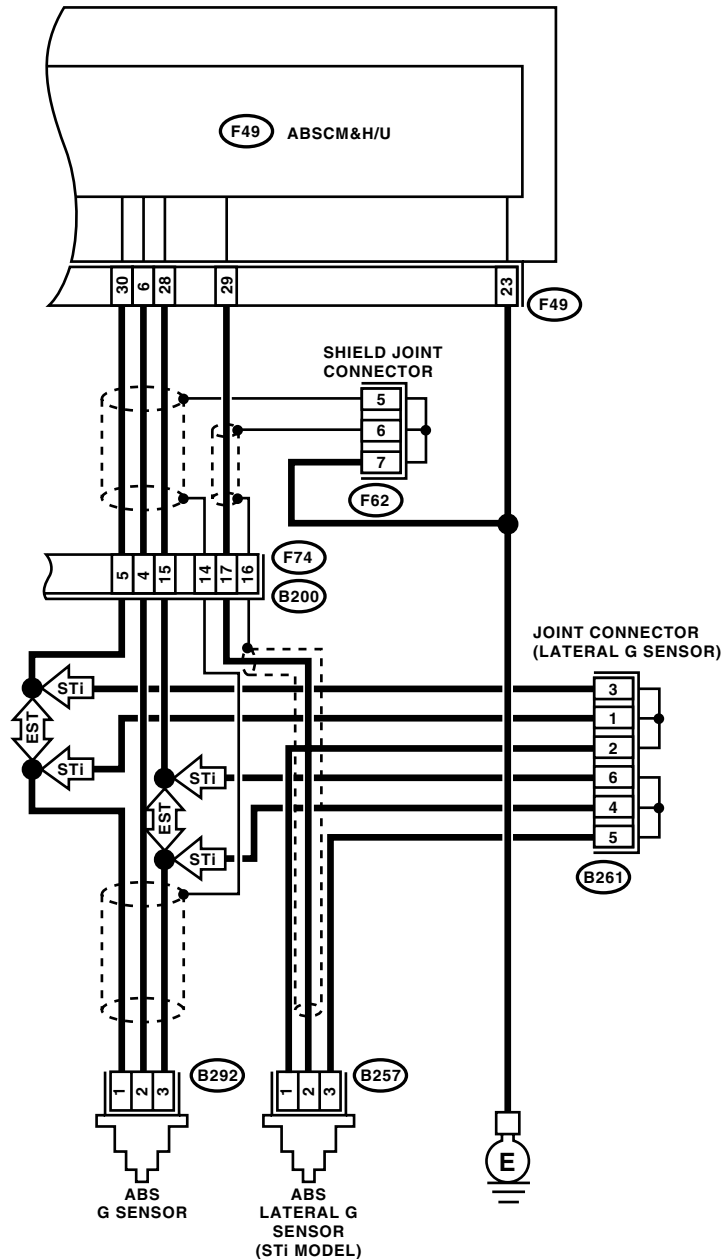

ABS00369

Step	Check	Yes	No	
1	<b>CHECK ALL FOUR WHEELS FOR FREE TURNING.</b>	Have the wheels been turned freely such as when vehicle is lifted up, or operated on a rolling road?	The ABS is normal. Erase the DTC.	Go to step 2.

## Diagnostics Procedure with Diagnostic Trouble Code (DTC)

### ABS (DIAGNOSTICS)

Step	Check	Yes	No
<b>2 CHECK OUTPUT OF G SENSOR USING SUBARU SELECT MONITOR.</b> 1) Select "Current data display & Save" on the Subaru Select Monitor. 2) Read the Subaru Select Monitor display.	Is the G sensor output on monitor display 2.1 — 2.5 V when the vehicle is in horizontal position?	Go to step 3.	Go to step 8.
<b>3 CHECK OUTPUT OF G SENSOR USING SUBARU SELECT MONITOR.</b> 1) Turn the ignition switch to OFF. 2) Remove the console box. 3) Remove the G sensor from vehicle. (Do not disconnect the connector.) 4) Turn the ignition switch to ON. 5) Select "Current data display & Save" on the Subaru Select Monitor. 6) Read the Subaru Select Monitor display.	Is the voltage 3.7 — 4.1 V when G sensor is inclined forwards to 90°?	Go to step 4.	Replace the G sensor. <Ref. to ABS-21, G Sensor.>
<b>4 CHECK OUTPUT OF G SENSOR USING SUBARU SELECT MONITOR.</b> Read the Subaru Select Monitor display.	Is the voltage 0.5 — 0.9 V when G sensor is inclined backwards to 90°?	Go to step 5.	Replace the G sensor. <Ref. to ABS-21, G Sensor.>
<b>5 CHECK POOR CONTACT IN CONNECTORS.</b> Turn the ignition switch to OFF.	Is there poor contact in connector between ABSCM&H/U and G sensor?	Repair the connector.	Go to step 6.
<b>6 CHECK ABSCM&amp;H/U.</b> 1) Connect all connectors. 2) Erase the memory. 3) Perform the inspection mode. 4) Read out the DTC.	Is the same DTC as in current diagnosis still being output?	Replace the ABSCM only. <Ref. to ABS-6, ABS Control Module and Hydraulic Control Unit (ABSCM&H/U).>	Go to step 7.
<b>7 CHECK ANY OTHER DTC APPEARANCE.</b>	Are other DTCs being output?	Proceed with the diagnosis corresponding to DTC.	A temporary poor contact.
<b>8 CHECK OPEN CIRCUIT IN G SENSOR OUTPUT HARNESS AND GROUND HARNESS.</b> 1) Turn the ignition switch to OFF. 2) Disconnect the connector from ABSCM&H/U. 3) Measure the resistance between ABSCM&H/U connector terminals. <i><b>Connector &amp; terminal</b></i> <i><b>LHD: (B301) No. 6 — No. 28:</b></i> <i><b>RHD: (F49) No. 6 — No. 28:</b></i>	Is the resistance 5.0 — 5.6 kΩ?	Go to step 9.	Repair the harness/connector between G sensor and ABSCM&H/U.
<b>9 CHECK G SENSOR.</b> 1) Remove the console box. 2) Remove the G sensor from vehicle. 3) Connect the connector to G sensor. 4) Connect the connector to ABSCM&H/U. 5) Turn the ignition switch to ON. 6) Measure the voltage between G sensor connector terminals. <i><b>Connector &amp; terminal</b></i> <i><b>(B292) No. 2 (+) — No. 3 (-):</b></i>	Is the voltage 2.1 — 2.5 V when G sensor is in horizontal position?	Go to step 10.	Replace the G sensor. <Ref. to ABS-21, G Sensor.>
<b>10 CHECK G SENSOR.</b> Measure the voltage between G sensor connector terminals. <i><b>Connector &amp; terminal</b></i> <i><b>(B292) No. 2 (+) — No. 3 (-):</b></i>	Is the voltage 3.7 — 4.1 V when G sensor is inclined forwards to 90°?	Go to step 11.	Replace the G sensor. <Ref. to ABS-21, G Sensor.>

# Diagnostics Procedure with Diagnostic Trouble Code (DTC)

ABS (DIAGNOSTICS)

Step	Check	Yes	No
<b>11 CHECK G SENSOR.</b> Measure the voltage between G sensor connector terminals. <i><b>Connector &amp; terminal</b></i> <i><b>(B292) No. 2 (+) — No. 3 (-):</b></i>	Is the voltage 0.5 — 0.9 V when G sensor is inclined backwards to 90°?	Go to step <b>12</b> .	Replace the G sensor. <Ref. to ABS-21, G Sensor.>
<b>12 CHECK ABSCM&amp;H/U.</b> 1)Turn the ignition switch to OFF. 2)Connect all connectors. 3)Erase the memory. 4)Perform the inspection mode. 5)Read out the DTC.	Is the same DTC as in current diagnosis still being output?	Replace the ABSCM only. <Ref. to ABS-6, ABS Control Module and Hydraulic Control Unit (ABSCM&H/U).>	Go to step <b>13</b> .
<b>13 CHECK ANY OTHER DTC APPEARANCE.</b>	Are other DTCs being output?	Proceed with the diagnosis corresponding to DTC.	A temporary poor contact.

# Diagnostics Procedure with Diagnostic Trouble Code (DTC)

ABS (DIAGNOSTICS)

## AI: DTC 73 OPEN OR SHORT CIRCUIT IN LATERAL G SENSOR CIRCUIT

### DIAGNOSIS:

- Faulty Lateral G sensor output voltage

### TROUBLE SYMPTOM:

- ABS does not operate.

### WIRING DIAGRAM:

LHD MODEL

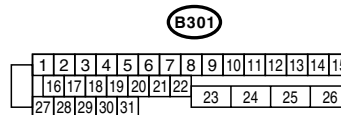
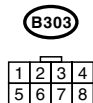
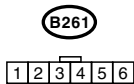
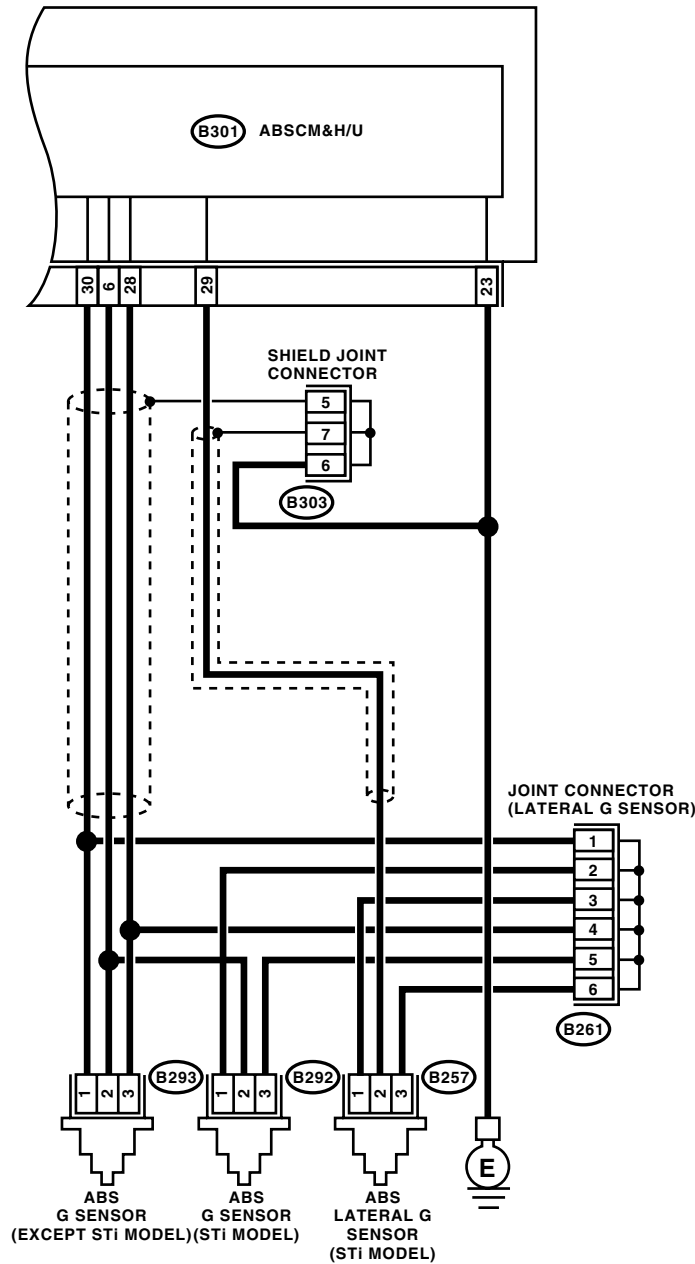

ABS00368

# Diagnostics Procedure with Diagnostic Trouble Code (DTC)

ABS (DIAGNOSTICS)

## RHD MODEL

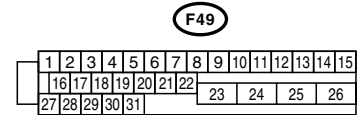
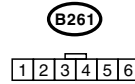
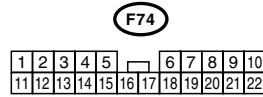
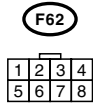
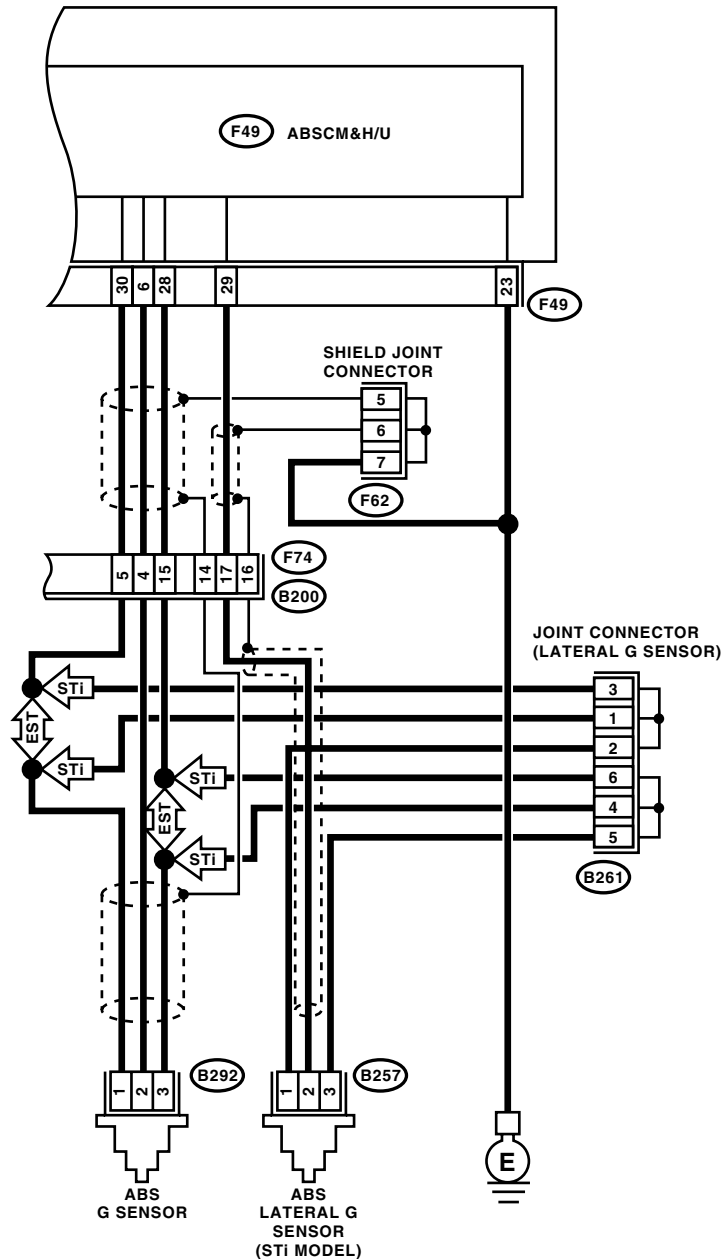

ABS00369

Step	Check	Yes	No	
1	<p><b>CHECK OUTPUT OF LATERAL G SENSOR USING SUBARU SELECT MONITOR.</b></p> <p>1) Select "Current data display &amp; Save" on the Subaru Select Monitor.</p> <p>2) Read the lateral G sensor output in Subaru Select Monitor data display.</p>	Is the lateral G sensor output on monitor display 2.3 — 2.7 V when lateral G sensor is in horizontal position?	Go to step 2.	Go to step 5.



## Diagnostics Procedure with Diagnostic Trouble Code (DTC)

ABS (DIAGNOSTICS)

Step	Check	Yes	No
<b>2</b>	<b>CHECK POOR CONTACT IN CONNECTORS.</b>	Is there poor contact in connector between ABSCM&H/U and lateral G sensor?	Repair the connector. Go to step <b>3</b> .
<b>3</b>	<b>CHECK ABSCM&amp;H/U.</b> 1)Connect all connectors. 2)Erase the memory. 3)Perform the inspection mode. 4)Read out the DTC.	Is the same DTC as in the current diagnosis still being output?	Replace the ABSCM only. <Ref. to ABS-6, ABS Control Module and Hydraulic Control Unit (ABSCM&H/U).> Go to step <b>4</b> .
<b>4</b>	<b>CHECK ANY OTHER DTC APPEARANCE.</b>	Are other DTCs being output?	Proceed with the diagnosis corresponding to DTC. A temporary poor contact.
<b>5</b>	<b>CHECK INPUT VOLTAGE OF LATERAL G SENSOR.</b> 1)Turn the ignition switch to OFF. 2)Remove the console box. 3)Remove the lateral G sensor from vehicle. (Do not disconnect connector.) 4)Turn the ignition switch to ON. 5)Measure the voltage between lateral G sensor connector terminals. <b>Connector &amp; terminal</b> <b>(B257) No. 1 (+) — No. 3 (-):</b>	Is the voltage 4.75 — 5.25 V?	Go to step <b>6</b> . Repair the harness/connector between lateral G sensor and ABSCM&H/U.
<b>6</b>	<b>CHECK OPEN CIRCUIT IN LATERAL G SENSOR OUTPUT HARNESS AND GROUND HARNESS.</b> 1)Turn the ignition switch to OFF. 2)Disconnect the connector from ABSCM&H/U. 3)Measure the resistance between ABSCM&H/U connector terminals. <b>Connector &amp; terminal</b> <b>LHD: (B301) No. 28 — No. 30:</b> <b>RHD: (F49) No. 28 — No. 30:</b>	Is the resistance 5.0 — 5.6 kΩ?	Go to step <b>7</b> . Repair the harness/connector between lateral G sensor and ABSCM&H/U.
<b>7</b>	<b>CHECK GROUND SHORT IN LATERAL G SENSOR OUTPUT HARNESS.</b> 1)Disconnect the connector from lateral G sensor. 2)Measure the resistance between ABSCM&H/U connector and chassis ground. <b>Connector &amp; terminal</b> <b>LHD: (B301) No. 29 — Chassis ground:</b> <b>RHD: (F49) No. 29 — Chassis ground:</b>	Is the resistance more than 1 MΩ?	Go to step <b>8</b> . Repair the harness between lateral G sensor and ABSCM&H/U.
<b>8</b>	<b>CHECK LATERAL G SENSOR.</b> 1)Connect the connector to lateral G sensor. 2)Connect the connector to ABSCM&H/U. 3)Turn the ignition switch to ON. 4)Measure the voltage between lateral G sensor connector terminals. <b>Connector &amp; terminal</b> <b>(B257) No. 2 (+) — No. 3 (-):</b>	Is the voltage 2.1 — 2.5 V when lateral G sensor is in horizontal position?	Go to step <b>9</b> . Replace the lateral G sensor. <Ref. to ABS-23, Lateral G Sensor.>
<b>9</b>	<b>CHECK LATERAL G SENSOR.</b> Measure the voltage between lateral G sensor connector terminals. <b>Connector &amp; terminal</b> <b>(B257) No. 2 (+) — No. 3 (-):</b>	Is the voltage 3.7 — 4.1 V when lateral G sensor is inclined right to 90°?	Go to step <b>10</b> . Replace the lateral G sensor. <Ref. to ABS-23, Lateral G Sensor.>

# Diagnostics Procedure with Diagnostic Trouble Code (DTC)

ABS (DIAGNOSTICS)

Step	Check	Yes	No
<b>10 CHECK LATERAL G SENSOR.</b> Measure the voltage between lateral G sensor connector terminals. <i><b>Connector &amp; terminal (B257) No. 2 (+) — No. 3 (-):</b></i>	Is the voltage 0.5 — 0.9 V when lateral G sensor is inclined left to 90°?	Go to step 11.	Replace the lateral G sensor. <Ref. to ABS-23, Lateral G Sensor.>
<b>11 CHECK POOR CONTACT IN CONNECTORS.</b> Turn the ignition switch to OFF.	Is there poor contact in connector between ABSCM&H/U and lateral G sensor?	Repair the connector.	Go to step 12.
<b>12 CHECK ABSCM&amp;H/U.</b> 1)Connect all connectors. 2)Erase the memory. 3)Perform the inspection mode. 4)Read out the DTC.	Is the same DTC as in current diagnosis still being output?	Replace the ABSCM only. <Ref. to ABS-6, ABS Control Module and Hydraulic Control Unit (ABSCM&H/U).>	Go to step 13.
<b>13 CHECK ANY OTHER DTC APPEARANCE.</b>	Are other DTCs being output?	Proceed with the diagnosis corresponding to DTC.	A temporary poor contact.

# Diagnostics Procedure with Diagnostic Trouble Code (DTC)

ABS (DIAGNOSTICS)

## AJ:DTC 73 BATTERY SHORT IN LATERAL G SENSOR CIRCUIT

### DIAGNOSIS:

- Faulty Lateral G sensor output voltage

### TROUBLE SYMPTOM:

- ABS does not operate.

### WIRING DIAGRAM:

LHD MODEL

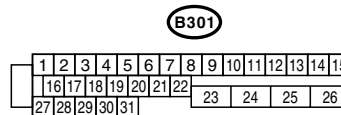
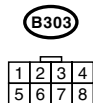
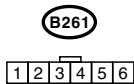
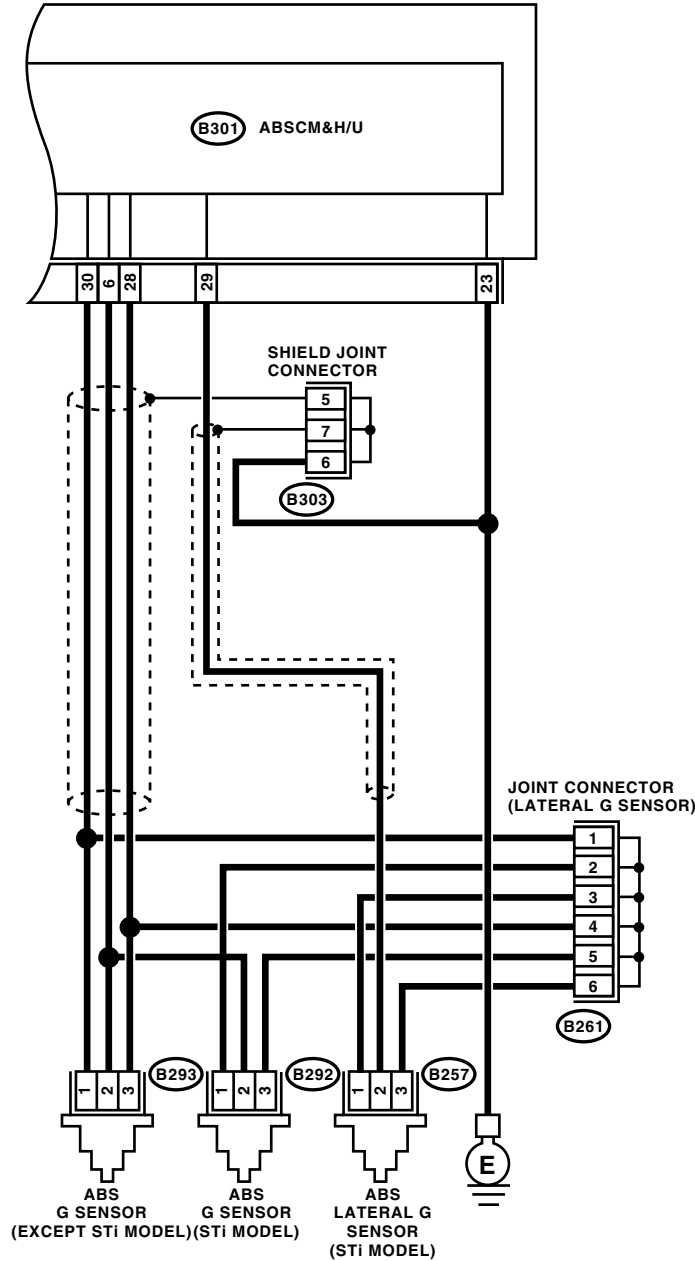

ABS00368

# Diagnostics Procedure with Diagnostic Trouble Code (DTC)

ABS (DIAGNOSTICS)

## RHD MODEL

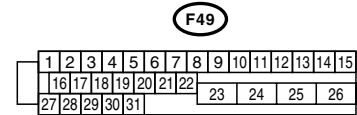
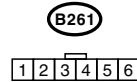
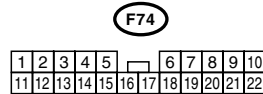
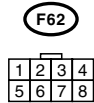
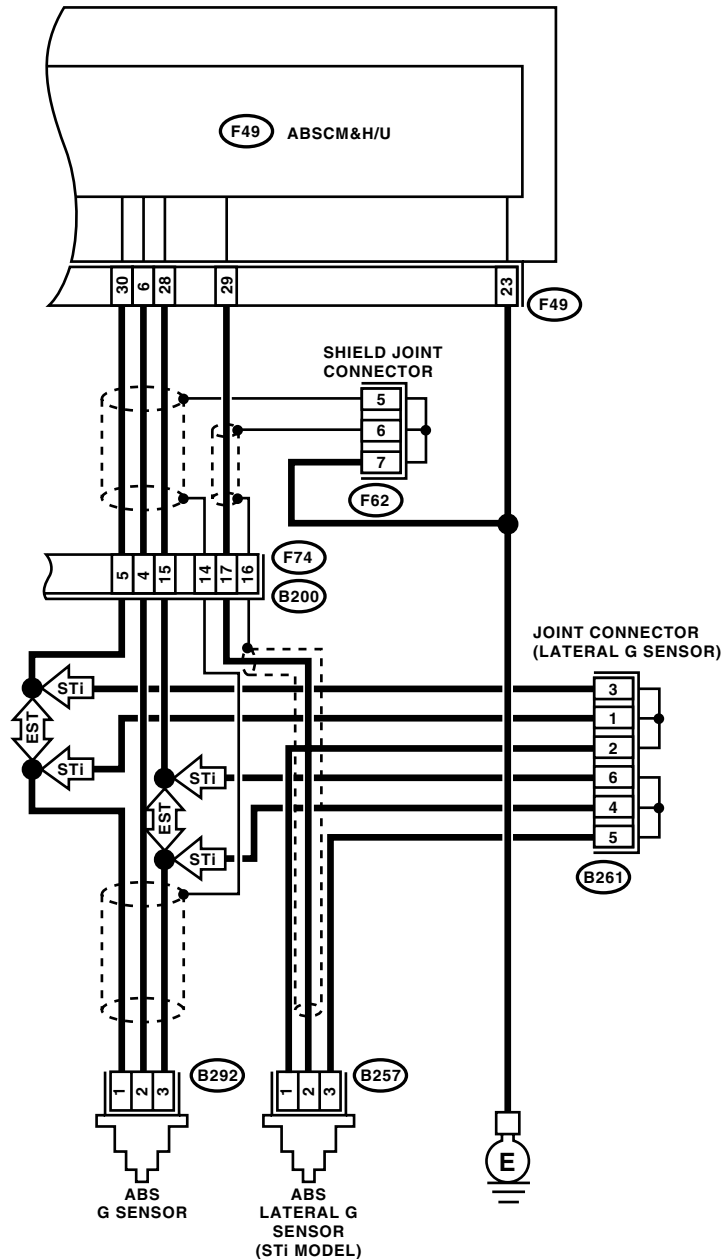

ABS00369

Step	Check	Yes	No	
1	<b>CHECK OUTPUT OF LATERAL G SENSOR USING SUBARU SELECT MONITOR.</b> 1) Select "Current data display & Save" on the Subaru Select Monitor. 2) Read the lateral G sensor output in Subaru Select Monitor data display.	Is the voltage 2.3 — 2.7 V when lateral G sensor is in horizontal position?	Go to step 2.	Go to step 5.

## Diagnostics Procedure with Diagnostic Trouble Code (DTC)

### ABS (DIAGNOSTICS)

Step	Check	Yes	No
<b>2</b>	<b>CHECK POOR CONTACT IN CONNECTORS.</b>	Is there poor contact in connector between ABSCM&H/U and lateral G sensor?	Repair the connector. Go to step <b>3</b> .
<b>3</b>	<b>CHECK ABSCM&amp;H/U.</b> 1)Connect all connectors. 2)Erase the memory. 3)Perform the inspection mode. 4)Read out the DTC.	Is the same DTC as in current diagnosis still being output?	Replace the ABSCM only. <Ref. to ABS-6, ABS Control Module and Hydraulic Control Unit (ABSCM&H/U).> Go to step <b>4</b> .
<b>4</b>	<b>CHECK ANY OTHER DTC APPEARANCE.</b>	Are other DTCs being output?	Proceed with the diagnosis corresponding to DTC. A temporary poor contact.
<b>5</b>	<b>CHECK FREEZE FRAME DATA.</b> 1)Select "Freeze frame data" on the Subaru Select Monitor. 2)Read front right wheel speed on the Subaru Select Monitor display.	Is the front right wheel speed on monitor display 0 km/h (0 MPH)?	Go to step <b>6</b> . Go to step <b>16</b> .
<b>6</b>	<b>CHECK FREEZE FRAME DATA.</b> Read front left wheel speed on the Subaru Select Monitor display.	Is the front left wheel speed on monitor display 0 km/h (0 MPH)?	Go to step <b>7</b> . Go to step <b>16</b> .
<b>7</b>	<b>CHECK FREEZE FRAME DATA.</b> Read rear right wheel speed on the Subaru Select Monitor display.	Is the rear right wheel speed on monitor display 0 km/h (0 MPH)?	Go to step <b>8</b> . Go to step <b>16</b> .
<b>8</b>	<b>CHECK FREEZE FRAME DATA.</b> Read rear left wheel speed on the Subaru Select Monitor display.	Is the rear left wheel speed on monitor display 0 km/h (0 MPH)?	Go to step <b>9</b> . Go to step <b>16</b> .
<b>9</b>	<b>CHECK FREEZE FRAME DATA.</b> Read lateral G sensor output on the Subaru Select Monitor display.	Is the lateral G sensor output on monitor display more than 3.65 V?	Go to step <b>10</b> . Go to step <b>16</b> .
<b>10</b>	<b>CHECK OPEN CIRCUIT IN LATERAL G SENSOR OUTPUT HARNESS AND GROUND HARNESS.</b> 1)Turn the ignition switch to OFF. 2)Disconnect the connector from ABSCM&H/U. 3)Measure the resistance between ABSCM&H/U connector terminals. <b>Connector &amp; terminal</b> <b>LHD: (B301) No. 29 — No. 28:</b> <b>RHD: (F49) No. 29 — No. 28:</b>	Is the resistance 4.3 — 4.9 kΩ?	Go to step <b>11</b> . Repair the harness/connector between Lateral G sensor and ABSCM&H/U.
<b>11</b>	<b>CHECK BATTERY SHORT OF HARNESS.</b> 1)Turn the ignition switch to OFF. 2)Remove the console box. 3)Disconnect the connector from lateral G sensor. 4)Disconnect the connector from ABSCM&H/U. 5)Measure the voltage between ABSCM&H/U connector and chassis ground. <b>Connector &amp; terminal</b> <b>LHD: (B301) No. 29 (+) — Chassis ground (-):</b> <b>RHD: (F49) No. 29 (+) — Chassis ground (-):</b>	Is the voltage less than 1 V?	Go to step <b>12</b> . Repair the harness between lateral G sensor and ABSCM&H/U.

# Diagnostics Procedure with Diagnostic Trouble Code (DTC)

ABS (DIAGNOSTICS)

Step	Check	Yes	No
<b>12 CHECK BATTERY SHORT OF HARNESS.</b> 1) Turn the ignition switch to ON. 2) Measure the voltage between ABSCM&H/U connector and chassis ground. <i>Connector &amp; terminal</i> <i>LHD: (B301) No. 29 (+) — Chassis ground (-);</i> <i>RHD: (F49) No. 29 (+) — Chassis ground (-);</i>	Is the voltage less than 1 V?	Go to step 13.	Repair the harness between lateral G sensor and ABSCM&H/U.
<b>13 CHECK POOR CONTACT IN CONNECTORS.</b>	Is there poor contact in connector between ABSCM&H/U and lateral G sensor?	Repair the connector.	Go to step 14.
<b>14 CHECK ABSCM&amp;H/U.</b> 1) Connect all connectors. 2) Erase the memory. 3) Perform the inspection mode. 4) Read out the DTC.	Is the same DTC as in current diagnosis still being output?	Replace the ABSCM only. <Ref. to ABS-6, ABS Control Module and Hydraulic Control Unit (ABSCM&H/U).>	Go to step 15.
<b>15 CHECK ANY OTHER DTC APPEARANCE.</b>	Are other DTCs being output?	Proceed with the diagnosis corresponding to DTC.	A temporary poor contact.
<b>16 CHECK INPUT VOLTAGE OF LATERAL G SENSOR.</b> 1) Turn the ignition switch to OFF. 2) Remove the console box. 3) Remove the lateral G sensor from vehicle. (Do not disconnect connector.) 4) Turn the ignition switch to ON. 5) Measure the voltage between lateral G sensor connector terminals. <i>Connector &amp; terminal</i> <i>(B257) No. 1 (+) — No. 3 (-);</i>	Is the voltage 4.75 — 5.25 V?	Go to step 17.	Repair the harness/connector between Lateral G sensor and ABSCM&H/U.
<b>17 CHECK OPEN CIRCUIT IN LATERAL G SENSOR OUTPUT HARNESS AND GROUND HARNESS.</b> 1) Turn the ignition switch to OFF. 2) Disconnect the connector from ABSCM&H/U. 3) Measure the resistance between ABSCM&H/U connector terminals. <i>Connector &amp; terminal</i> <i>LHD: (B301) No. 29 — No. 28;</i> <i>RHD: (F49) No. 29 — No. 28;</i>	Is the resistance 5.0 — 5.6 kΩ?	Go to step 18.	Repair the harness/connector between lateral G sensor and ABSCM&H/U.
<b>18 CHECK LATERAL G SENSOR.</b> 1) Connect the connector to lateral G sensor. 2) Connect the connector to ABSCM&H/U. 3) Turn the ignition switch to ON. 4) Measure the voltage between lateral G sensor connector terminals. <i>Connector &amp; terminal</i> <i>(B257) No. 2 (+) — No. 3 (-);</i>	Is the voltage 2.1 — 2.5 V when lateral G sensor is in horizontal position?	Go to step 19.	Replace the lateral G sensor. <Ref. to ABS-23, Lateral G Sensor.>
<b>19 CHECK LATERAL G SENSOR.</b> Measure the voltage between lateral G sensor connector terminals. <i>Connector &amp; terminal</i> <i>(B257) No. 2 (+) — No. 3 (-);</i>	Is the voltage 3.3 — 3.7 V when lateral G sensor is inclined right to 90°?	Go to step 20.	Replace the lateral G sensor. <Ref. to ABS-23, Lateral G Sensor.>

## Diagnostics Procedure with Diagnostic Trouble Code (DTC)

ABS (DIAGNOSTICS)

Step	Check	Yes	No
<b>20 CHECK LATERAL G SENSOR.</b> Measure the voltage between lateral G sensor connector terminals. <i><b>Connector &amp; terminal (B257) No. 2 (+) — No. 3 (-):</b></i>	Is the voltage 0.5 — 0.9 V when lateral G sensor is inclined left to 90°?	Go to step <b>21</b> .	Replace the lateral G sensor. <Ref. to ABS-23, Lateral G Sensor.>
<b>21 CHECK POOR CONTACT IN CONNECTORS.</b> Turn the ignition switch to OFF.	Is there poor contact in connector between ABSCM&H/U and lateral G sensor?	Repair the connector.	Go to step <b>22</b> .
<b>22 CHECK ABSCM&amp;H/U.</b> 1)Connect all connectors. 2)Erase the memory. 3)Perform the inspection mode. 4)Read out the DTC.	Is the same DTC as in current diagnosis still being output?	Replace the ABSCM only. <Ref. to ABS-6, ABS Control Module and Hydraulic Control Unit (ABSCM&H/U).>	Go to step <b>23</b> .
<b>23 CHECK ANY OTHER DTC APPEARANCE.</b>	Are other DTCs being output?	Proceed with the diagnosis corresponding to DTC.	A temporary poor contact.

## AK:DTC 73 ABNORMAL LATERAL G SENSOR HIGH $\mu$ OUTPUT

### DIAGNOSIS:

- Faulty Lateral G sensor output voltage

### TROUBLE SYMPTOM:

- ABS does not operate.

### WIRING DIAGRAM:

#### LHD MODEL

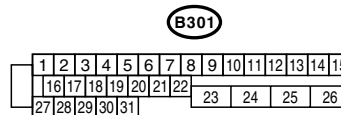
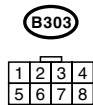
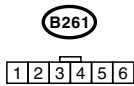
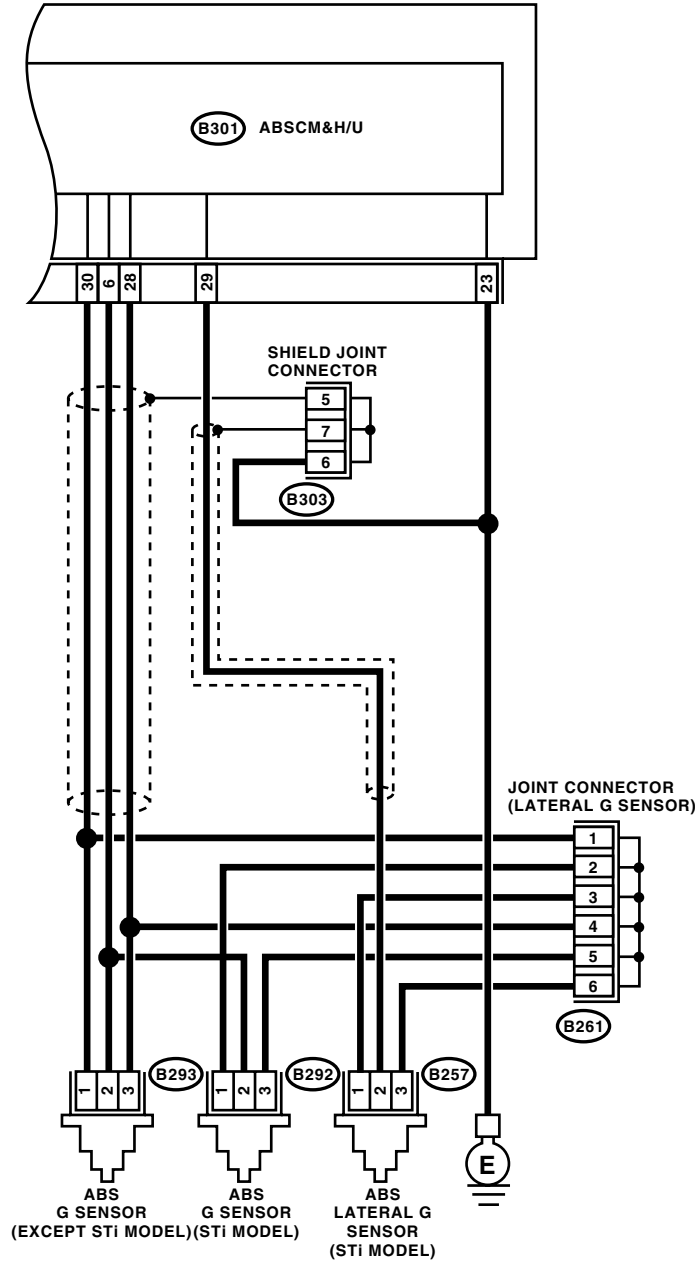



# Diagnostics Procedure with Diagnostic Trouble Code (DTC)

ABS (DIAGNOSTICS)

RHD MODEL

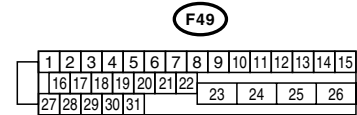
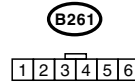
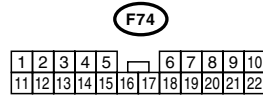
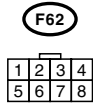
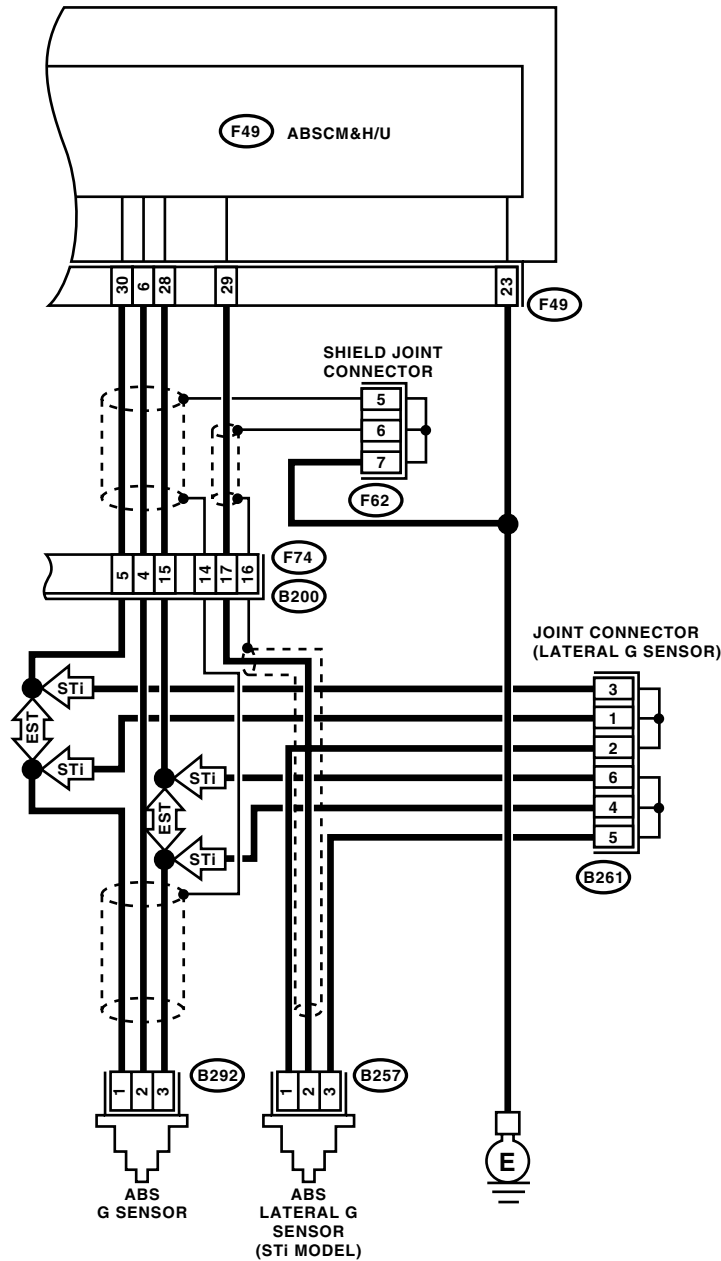

ABS00369

Step	Check	Yes	No	
1	<p><b>CHECK OUTPUT OF LATERAL G SENSOR USING SUBARU SELECT MONITOR.</b></p> <p>1) Select "Current data display &amp; Save" on the Subaru Select Monitor.</p> <p>2) Read Lateral G sensor output on the Subaru Select Monitor display.</p>	Is the voltage 2.3 — 2.7 V when Lateral G sensor is in horizontal position?	Go to step 2.	Go to step 6.

# Diagnostics Procedure with Diagnostic Trouble Code (DTC)

ABS (DIAGNOSTICS)

Step	Check	Yes	No
2	<b>CHECK POOR CONTACT IN CONNECTORS.</b> Turn the ignition switch to OFF.	Is there poor contact in connector between ABSCM&H/U and lateral G sensor?	Repair the connector.  Go to step 3.
3	<b>CHECK ABSCM&amp;H/U.</b> 1)Connect all connectors. 2)Erase the memory. 3)Perform the inspection mode. 4)Read out the DTC.	Is the same DTC as in current diagnosis still being output?	Replace the ABSCM only. <Ref. to ABS-6, ABS Control Module and Hydraulic Control Unit (ABSCM&H/U).>  Go to step 4.
4	<b>CHECK ANY OTHER DTC APPEARANCE.</b>	Are other DTCs being output?	Proceed with the diagnosis corresponding to DTC.  A temporary poor contact.
5	<b>CHECK OPEN CIRCUIT IN LATERAL G SENSOR OUTPUT HARNESS AND GROUND HARNESS.</b> 1)Turn the ignition switch to OFF. 2)Disconnect the connector from ABSCM&H/U. 3)Measure the resistance between ABSCM&H/U connector terminals. <b>Connector &amp; terminal</b> <b>LHD: (B301) No. 29 — No. 28:</b> <b>RHD: (F49) No. 29 — No. 28:</b>	Is the resistance 5.0 — 5.6 kΩ?	Go to step 6.  Repair the harness/connector between lateral G sensor and ABSCM&H/U.
6	<b>CHECK GROUND SHORT OF HARNESS.</b> Measure the resistance between ABSCM&H/U connector and chassis ground. <b>Connector &amp; terminal</b> <b>LHD: (B301) No. 28 — Chassis ground:</b> <b>RHD: (F49) No. 28 — Chassis ground:</b>	Is the resistance more than 1 MΩ?	Go to step 7.  Repair the harness between lateral G sensor and ABSCM only. Replace the ABSCM&H/U. <Ref. to ABS-6, ABS Control Module and Hydraulic Control Unit (ABSCM&H/U).>
7	<b>CHECK LATERAL G SENSOR.</b> 1)Remove the console box. 2)Remove the lateral G sensor from vehicle. 3)Connect the connector to lateral G sensor. 4)Connect the connector to ABSCM&H/U. 5)Turn the ignition switch to ON. 6)Measure the voltage between lateral G sensor connector terminals. <b>Connector &amp; terminal</b> <b>(B257) No. 2 (+) — No. 3 (-):</b>	Is the voltage 2.1 — 2.5 V when lateral G sensor is in horizontal position?	Go to step 8.  Replace the lateral G sensor. <Ref. to ABS-23, Lateral G Sensor.>
8	<b>CHECK LATERAL G SENSOR.</b> Measure the voltage between lateral G sensor connector terminals. <b>Connector &amp; terminal</b> <b>(B257) No. 2 (+) — No. 3 (-):</b>	Is the voltage 3.3 — 3.7 V when lateral G sensor is inclined right to 90°?	Go to step 9.  Replace the lateral G sensor. <Ref. to ABS-23, Lateral G Sensor.>
9	<b>CHECK LATERAL G SENSOR.</b> Measure the voltage between lateral G sensor connector terminals. <b>Connector &amp; terminal</b> <b>(B257) No. 2 (+) — No. 3 (-):</b>	Is the voltage 0.5 — 0.9 V when lateral G sensor is inclined left to 90°?	Go to step 10.  Replace the lateral G sensor. <Ref. to ABS-23, Lateral G Sensor.>

## Diagnosics Procedure with Diagnostic Trouble Code (DTC)

### ABS (DIAGNOSTICS)

Step	Check	Yes	No
<b>10</b> <b>CHECK ABSCM&amp;H/U.</b> 1)Turn the ignition switch to OFF. 2)Connect all connectors. 3)Erase the memory. 4)Perform the inspection mode. 5)Read out the DTC.	Is the same DTC as in current diagnosis still being output?	Replace the ABSCM only. <Ref. to ABS-6, ABS Control Module and Hydraulic Control Unit (ABSCM&H/U).>	Go to step 11.
<b>11</b> <b>CHECK ANY OTHER DTC APPEARANCE.</b>	Are other DTCs being output?	Proceed with the diagnosis corresponding to DTC.	A temporary poor contact.

## AL:DTC 73 DETECTION OF LATERAL G SENSOR STICK

**DIAGNOSIS:**

- Faulty Lateral G sensor output voltage

**TROUBLE SYMPTOM:**

- ABS does not operate.

**WIRING DIAGRAM:**

LHD MODEL

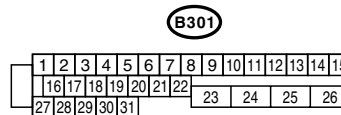
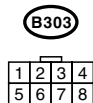
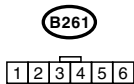
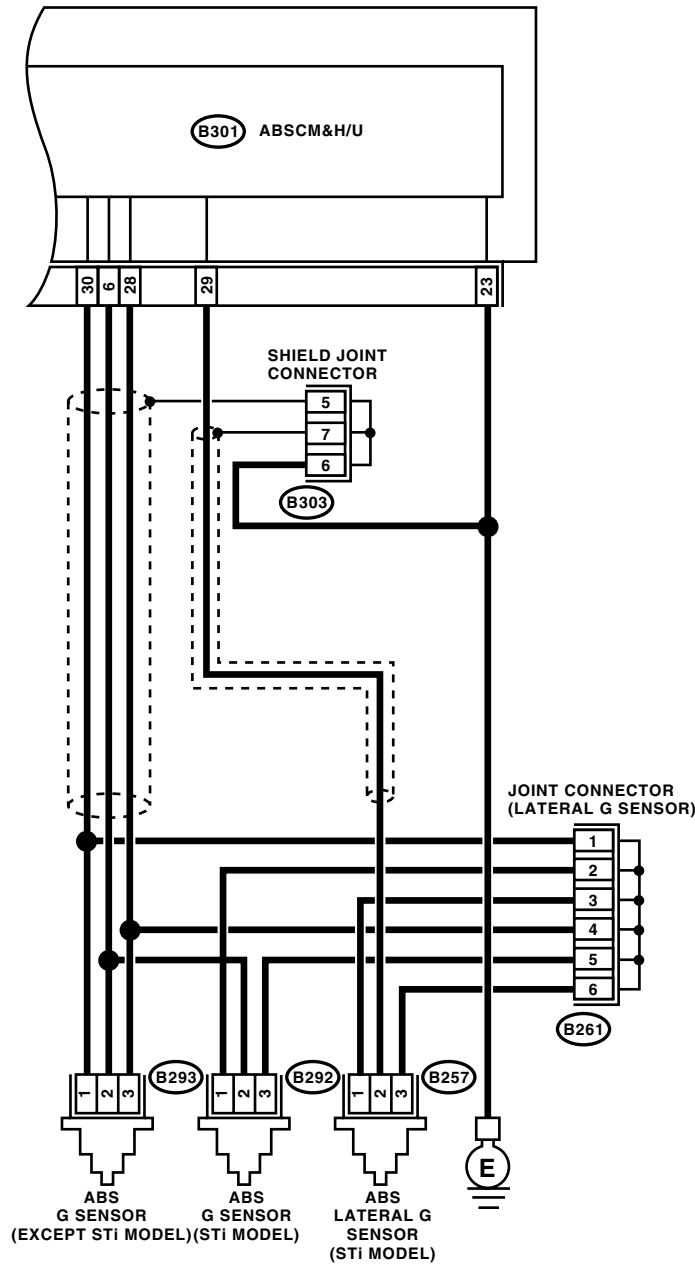

# Diagnostics Procedure with Diagnostic Trouble Code (DTC)

ABS (DIAGNOSTICS)

**RHD MODEL**

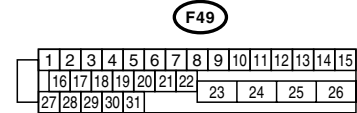
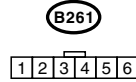
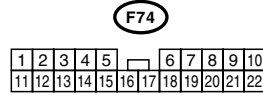
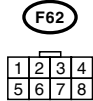
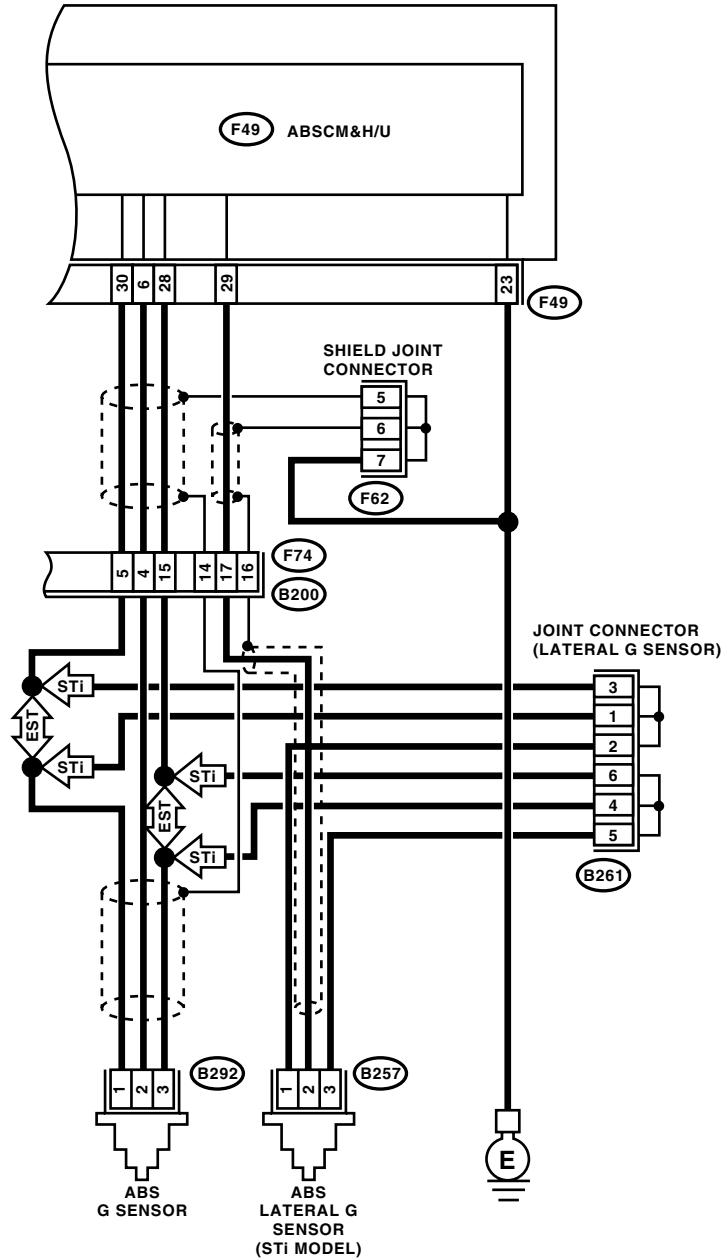

ABS00369

Step	Check	Yes	No	
1	<b>CHECK ALL FOUR WHEELS FOR FREE TURNING.</b>	Have the wheels been turned freely such as when vehicle is lifted up, or operated on a rolling road?	The ABS is normal. Erase the DTC.	Go to step 2.

# Diagnostics Procedure with Diagnostic Trouble Code (DTC)

ABS (DIAGNOSTICS)

Step	Check	Yes	No
<b>2 CHECK OUTPUT OF LATERAL G SENSOR USING SUBARU SELECT MONITOR.</b> 1) Select "Current data display & Save" on the Subaru Select Monitor. 2) Read the Subaru Select Monitor display.	Is the lateral G sensor output on monitor display 2.3 — 2.7 V when the vehicle is in horizontal position?	Go to step 3.	Go to step 8.
<b>3 CHECK OUTPUT OF LATERAL G SENSOR USING SUBARU SELECT MONITOR.</b> 1) Turn the ignition switch to OFF. 2) Remove the console box. 3) Remove the lateral G sensor from vehicle. (Do not disconnect the connector.) 4) Turn the ignition switch to ON. 5) Select "Current data display & Save" on the Subaru Select Monitor. 6) Read the Subaru Select Monitor display.	Is the voltage 3.7 — 4.1 V when lateral G sensor is inclined right to 90°?	Go to step 4.	Replace the lateral G sensor. <Ref. to ABS-23, Lateral G Sensor.>
<b>4 CHECK OUTPUT OF LATERAL G SENSOR USING SUBARU SELECT MONITOR.</b> Read the Subaru Select Monitor display.	Is the voltage 0.5 — 0.9 V when lateral G sensor is inclined left to 90°?	Go to step 5.	Replace the lateral G sensor. <Ref. to ABS-23, Lateral G Sensor.>
<b>5 CHECK POOR CONTACT IN CONNECTORS.</b> Turn the ignition switch to OFF.	Is there poor contact in connector between ABSCM&H/U and lateral G sensor?	Repair the connector.	Go to step 6.
<b>6 CHECK ABSCM&amp;H/U.</b> 1) Connect all connectors. 2) Erase the memory. 3) Perform the inspection mode. 4) Read out the DTC.	Is the same DTC as in current diagnosis still being output?	Replace the ABSCM&H/U. <Ref. to ABS-6, ABS Control Module and Hydraulic Control Unit (ABSCM&H/U).>	Go to step 7.
<b>7 CHECK ANY OTHER DTC APPEARANCE.</b>	Are other DTCs being output?	Proceed with the diagnosis corresponding to DTC.	A temporary poor contact.
<b>8 CHECK OPEN CIRCUIT IN LATERAL G SENSOR OUTPUT HARNESS AND GROUND HARNESS.</b> 1) Turn the ignition switch to OFF. 2) Disconnect the connector from ABSCM&H/U. 3) Measure the resistance between ABSCM&H/U connector terminals. <b>Connector &amp; terminal</b> <b>LHD: (B301) No. 29 — No. 28:</b> <b>RHD: (F49) No. 29 — No. 28:</b>	Is the resistance 5.0 — 5.6 kΩ?	Go to step 9.	Repair the harness/connector between lateral G sensor and ABSCM&H/U.
<b>9 CHECK LATERAL G SENSOR.</b> 1) Remove the console box. 2) Remove the lateral G sensor from vehicle. 3) Connect the connector to lateral G sensor. 4) Connect the connector to ABSCM&H/U. 5) Turn the ignition switch to ON. 6) Measure the voltage between lateral G sensor connector terminals. <b>Connector &amp; terminal</b> <b>(B257) No. 2 (+) — No. 3 (-):</b>	Is the voltage 2.1 — 2.5 V when lateral G sensor is in horizontal position?	Go to step 10.	Replace the lateral G sensor. <Ref. to ABS-23, Lateral G Sensor.>
<b>10 CHECK LATERAL G SENSOR.</b> Measure the voltage between lateral G sensor connector terminals. <b>Connector &amp; terminal</b> <b>(B257) No. 2 (+) — No. 3 (-):</b>	Is the voltage 3.3 — 3.7 V when lateral G sensor is inclined right to 90°?	Go to step 11.	Replace the lateral G sensor. <Ref. to ABS-23, Lateral G Sensor.>

## Diagnostics Procedure with Diagnostic Trouble Code (DTC)

ABS (DIAGNOSTICS)

Step	Check	Yes	No
<b>11 CHECK LATERAL G SENSOR.</b> Measure the voltage between lateral G sensor connector terminals. <i><b>Connector &amp; terminal</b></i> <i><b>(B257) No. 2 (+) — No. 3 (-):</b></i>	Is the voltage 0.5 — 0.9 V when lateral G sensor is inclined left to 90°?	Go to step <b>12</b> .	Replace the lateral G sensor. <Ref. to ABS-23, Lateral G Sensor.>
<b>12 CHECK ABSCM&amp;H/U.</b> 1)Turn the ignition switch to OFF. 2)Connect all connectors. 3)Erase the memory. 4)Perform the inspection mode. 5)Read out the DTC.	Is the same DTC as in current diagnosis still being output?	Replace the ABSCM only. <Ref. to ABS-6, ABS Control Module and Hydraulic Control Unit (ABSCM&H/U).>	Go to step <b>13</b> .
<b>13 CHECK ANY OTHER DTC APPEARANCE.</b>	Are other DTCs being output?	Proceed with the diagnosis corresponding to DTC.	A temporary poor contact.

## 14. General Diagnostics Table

### A: INSPECTION

Symptom		Probable faulty units/parts
Vehicle instability during braking	Vehicle pulls to either side.	<ul style="list-style-type: none"> <li>• ABSCM&amp;H/U (solenoid valve)</li> <li>• ABS wheel speed sensor</li> <li>• Brake (caliper &amp; piston, pads)</li> <li>• Wheel alignment</li> <li>• Tire specifications, tire wear and air pressures</li> <li>• Incorrect wiring or piping connections</li> <li>• Road surface (uneven, camber)</li> </ul>
	Vehicle spins.	<ul style="list-style-type: none"> <li>• ABSCM&amp;H/U (solenoid valve)</li> <li>• ABS wheel speed sensor</li> <li>• Brake (pads)</li> <li>• Tire specifications, tire wear and air pressures</li> <li>• Incorrect wiring or piping connections</li> </ul>
Poor braking	Long braking/stopping distance	<ul style="list-style-type: none"> <li>• ABSCM&amp;H/U (solenoid valve)</li> <li>• Brake (pads)</li> <li>• Air in brake line</li> <li>• Tire specifications, tire wear and air pressures</li> <li>• Incorrect wiring or piping connections</li> </ul>
	Wheel locks.	<ul style="list-style-type: none"> <li>• ABSCM&amp;H/U (solenoid valve, motor)</li> <li>• ABS wheel speed sensor</li> <li>• Incorrect wiring or piping connections</li> </ul>
	Brake dragging	<ul style="list-style-type: none"> <li>• ABSCM&amp;H/U (solenoid valve)</li> <li>• ABS wheel speed sensor</li> <li>• Master cylinder</li> <li>• Brake (caliper &amp; piston)</li> <li>• Parking brake</li> <li>• Axle &amp; wheels</li> <li>• Brake pedal play</li> </ul>
	Long brake pedal stroke	<ul style="list-style-type: none"> <li>• Air in brake line</li> <li>• Brake pedal play</li> </ul>
	Vehicle pitching	<ul style="list-style-type: none"> <li>• Suspension play or fatigue (reduced damping)</li> <li>• Incorrect wiring or piping connections</li> <li>• Road surface (uneven)</li> </ul>
	Unstable or uneven braking	<ul style="list-style-type: none"> <li>• ABSCM&amp;H/U (solenoid valve)</li> <li>• ABS wheel speed sensor</li> <li>• Brake (caliper &amp; piston, pads)</li> <li>• Tire specifications, tire wear and air pressures</li> <li>• Incorrect wiring or piping connections</li> <li>• Road surface (uneven)</li> </ul>
	Excessive pedal vibration	<ul style="list-style-type: none"> <li>• Incorrect wiring or piping connections</li> <li>• Road surface (uneven)</li> </ul>
Vibration and/or noise (while driving on slippery roads)	Noise from ABSCM&H/U	<ul style="list-style-type: none"> <li>• ABSCM&amp;H/U (mount bushing)</li> <li>• ABS wheel speed sensor</li> <li>• Brake piping</li> </ul>
	Noise from front of vehicle	<ul style="list-style-type: none"> <li>• ABSCM&amp;H/U (mount bushing)</li> <li>• ABS wheel speed sensor</li> <li>• Master cylinder</li> <li>• Brake (caliper &amp; piston, pads, rotor)</li> <li>• Brake piping</li> <li>• Brake booster &amp; check valve</li> <li>• Suspension play or fatigue</li> </ul>
	Noise from rear of vehicle	<ul style="list-style-type: none"> <li>• ABS wheel speed sensor</li> <li>• Brake (caliper &amp; piston, pads, rotor)</li> <li>• Parking brake</li> <li>• Brake piping</li> <li>• Suspension play or fatigue</li> </ul>



# General Diagnostics Table

ABS (DIAGNOSTICS)

---